

ABINCA

CATÁLOGO DE HERRAMIENTAS PARA TALLER E INDUSTRIA



REVISIÓN 2023
1/3/23

www.abinca.com

TABLA DE CONTENIDOS



DESCRIPCIÓN	PÁGINA
LLAVES DE IMPACTO	2-4
CARRACAS	5
TALADROS	6-7
LIJADORAS	8-9
PULIDORAS / AMOLADORAS	10-11
ATORNILLADORES	12-13
MARTILLO CINCELADORES	14
CORTADORAS	15
REMACHADORAS	16
QUITAPUNTOS / DESABOLLADOR	17
SACALUNAS / DOBLADORA PERFORADORA	17
CLAVADORAS / GRAPADORAS	18-19
PISTOLAS	20-21
LIMPIEZA	22
ELÉCTRICA	23
SOLDADORES PARA PLÁSTICO	24

DESCRIPCIÓN	PÁGINA
CHAPA	25-27
HERRAMIENTAS PARA AUTOMOCIÓN	27-31
RUEDAS	32-33
TACOS	34-35
VARIOS	36
TENSORES	37
ACCESORIOS	37-39
MANGUERAS / ESPIRALES	40
FILTROS / REGULADORES / LUBRICADORES	40-42
LIJAS / DISCOS	43-44
ENCHUFES / CONEXIONES	45-47
GENERADOR OZONO / COMPRESOR	48
FACTORES DE CONVERSION	49
ANOTACIONES	49
RESTAURADOR DE FAROS	55



DESCRIPCIÓN	PÁGINA
TRATAMIENTOS Y LUBRICANTES	50-54



DESCRIPCIÓN	PÁGINA
LLAVES CARRACA	57
LLAVES DINAMOMÉTRICAS / HEX. y TORX	58
MALETINES	59-61
CARROS DE HERRAMIENTAS	62-63
LLAVES Y MÓDULOS	63-73
VASOS CORTOS	74
VASOS LARGOS	75

DESCRIPCIÓN	PÁGINA
VARIEDAD / ACCESORIOS	76-78
VASOS DE IMPACTO	79-81
REDUCTORES DE IMPACTO	82
ARTICULACIONES DE IMPACTO	82
EXTRACTORES	83
VASOS PUNTA IMPACTO	83
PUNTAS 10mm / VASOS PUNTA DE 1/4"	84-85

NUESTRAS MARCAS

*Para otros tipos de herramienta consulte con nosotros



AR PNEUMATIC

artículos subrayados en azul

La mejor relación calidad precio.



AB TOOLS

artículos subrayados en negro

Marca propia de distintos proveedores.



DP

artículos subrayados en verde

Gama semiprofesional.



CUSTOR

artículos subrayados en naranja

Herramientas manuales de alta calidad.



TETRALUBE

artículos subrayados en amarillo

Tratamientos y lubricantes de última generación.

- Esta tarifa entra en vigor el 1 de Marzo de 2024 y anula todas las anteriores.
 - En estos precios no está incluido el I.V.A. pudiendo sufrir variaciones, sin previo aviso.
 - Los portes pagados serán a partir de 300 € netos. Todos los pedidos inferiores a 60 € serán enviados contra reembolso.
 - Las características técnicas, peso, etc... sólo son indicativas y sujetas a cambios por el fabricante.
 - No se admitirán devoluciones pasados quince días de la entrega de la mercancía (sin previo aviso).
 - Toda la mercancía suministrada será de nuestra propiedad hasta que el cliente no haga efectivo el pago de la misma.
 - Tarifa válida salvo error tipográfico.
- Nuestros productos están garantizados por veinticuatro meses contra todo defecto de fabricación.
Esta garantía no cubre las averías por uso indebido, rotura, humedad, falta de mantenimiento o las piezas que sufran desgaste por el uso, aunque estén dentro del período de garantía. Toda máquina averiada, sea en garantía o no, viajará siempre a cargo del cliente.

AR-2041SK

P.V.P: 185€

LLAVE 1/4" PARA CALENTADORES

Contenido:

- Llave de impacto de 1/4"
- Alargo de 50mm.
- Vaso de impacto de 12mm.
- Vaso de impacto de 11mm.
- Vaso de impacto de 10mm.
- Vaso de impacto de 9mm.
- Vaso de impacto de 8mm.
- Articulación



Fuerza regulable:
10Nm, 20Nm, 30Nm y 40Nm.
Presión recomendada 90 psi.

Ref: 2032032

AR-2001S

P.V.P: 95€

LLAVE DE IMPACTO DE 3/8"

	9.000 rpm
	102 Nm apriete
	0,89 Kg



Ref: 2032051

AR-2006J

P.V.P: 139€

LLAVE DE IMPACTO DE 3/8"

	10000 rpm
	272 Nm apriete
	1,37 Kg



Ref: 2032052-A

AR-2005PT

P.V.P: 160€

LLAVE DE IMPACTO DE 1/2"

	10000 rpm
	434 Nm
	COMPOSITE! 1,20 kg



Ref: 2032048

AR-2056PT

P.V.P: 234€

MINI LLAVE DE IMPACTO ARTICULADA 1/2"

	500 Nm apriete
	8,5 Cm



Ref: 2032066

Gatillo con velocidad ajustable.
Mango ergonómico.
Empuñadura giratoria.
Carcasa ligera de aluminio.
Bajo nivel de sonido.
Ángulo ajustable 120°.
Ancho cabeza: 85mm.
Largo: 277mm.
Peso: 1,3kg

AR-2009RK

P.V.P: 195€

LLAVE DE IMPACTO 1/2"+CARRACA 1/2" (AR-2504)

- 9, 10,
- 11, 13,
- 14, 17,
- 19, 22,
- 24, 27 mm

características llave de impacto:

	313 Nm apriete
--	----------------



Ref: 2032055

	1,14 Kg
	7.000 rpm

AB-112F2K

P.V.P: 199€

MALETÍN AB-112F1 CON VASOS DE IMPACTO (1/2")

Incluye:

Llave de impacto AB-112F2 (1200Nm apriete)
Vasos de impacto largos 17 - 19 - 21



Ref: 2031009

AB-112XK

P.V.P: 288€

MALETÍN AB-112X CON VASOS DE IMPACTO (1/2")

Incluye:

Llave de impacto AB-112X (1492Nm apriete)
Vasos de impacto largos 17 - 19 - 21



Ref: 2031010

AB-134NK

P.V.P: 420€

MALETÍN AB-134N CON VASOS DE IMPACTO (3/4")

Incluye:

Llave de impacto AB-134N (1900Nm apriete)
Vasos de impacto largos 27 - 32 - 33



Ref: 2031011A

AB-112F2 P.V.P: 136€
LLAVE DE IMPACTO DE 1/2"



Ref: 2031004

	 1200 Nm apriete
 1600 Nm afloje	 8.500 rpm
 SEMI-COMPOSITE! 2 kg	

AB-112X P.V.P: 240€
LLAVE DE IMPACTO DE 1/2"



Ref: 2031001







	 1492 Nm apriete
 6.800 rpm	 COMPOSITE! 1.90 kg

super power

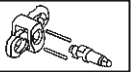
AB-112F3 P.V.P: 161€
MINI LLAVE DE IMPACTO 1/2"

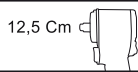





Ref: 2031015

	 12.000 rpm	 12,5 Cm
 900 Nm apriete	 1200 Nm afloje	 COMPOSITE! 1.20 kg

AR-2045T P.V.P: 289€
LLAVE DE IMPACTO DE 1/2"

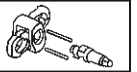

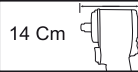
Ref: 2032087

	 7.000 rpm	 14 Cm
 1356Nm apriete	 COMPOSITE! 1.70 kg	

AR-1130 P.V.P: 162€
LLAVE DE IMPACTO DE 1/2"



Ref: 2032088

	 10000 rpm	 12,5 Cm
 678 Nm apriete	 1.50 kg	

AR-2043J P.V.P: 239€
LLAVE DE IMPACTO DE 1/2"



Ref: 2032086

	 9,7 Cm
 678 Nm apriete	 Kg 1,65 Kg
 9.500 rpm	

AR-2023T P.V.P: 189€
LLAVE DE IMPACTO DE 1/2"



Ref: 2032064-A

	 610 Nm apriete
 Kg 2,60 Kg	 8.000 rpm

AR-2018 P.V.P: 360€
LLAVE DE IMPACTO DE 3/4"



Ref: 2032060

	1084 Nm apriete	4500 rpm
	4,80 Kg	

AB-134N P.V.P: 374€
LLAVE DE IMPACTO DE 3/4"



Ref: 2031011

	1900 Nm apriete	5300 rpm
	COMPOSITE! 2.00 kg	*entrada de aire 1/4"

AR-278V-SR P.V.P: 676€
LLAVE DE IMPACTO DE 3/4"



Ref: 2032068

	1904 Nm apriete	5300 rpm
	COMPOSITE! 3.35 kg	*entrada de aire 3/8"

AR-2019NS P.V.P: 679€
LLAVE DE IMPACTO DE 1"

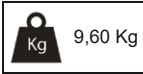
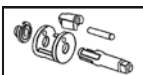

Ref: 2032061

AR-2039PT P.V.P: 834€
LLAVE DE IMPACTO DE 1"

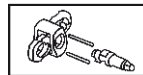

Ref: 2032069

AR-2019NSL LLAVE DE IMPACTO 1"

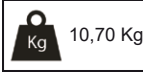

P.V.P: 724€



Ref: 2032063

*entrada de aire 1/2"

AR-2039PTL LLAVE DE IMPACTO 1"



P.V.P: 855€



Ref: 2032069-L

*entrada de aire 3/8"

AB-1100L P.V.P: Consultar
LLAVE DE IMPACTO DE 1"

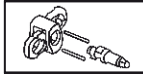
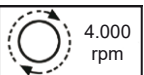

Ref: 2031002

*entrada de aire 1/2"

AR-2035PTL P.V.P: 1.330€
LLAVE DE IMPACTO DE 1"

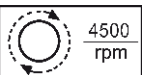
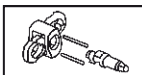

Ref: 2032049

*entrada de aire 1/2"

AR-2501 P.V.P: 90€
LLAVE CARRACA 1/4"

	 0,55 Kg
 250 rpm	
 27 Nm	



Ref: 2032039

AR-2401 P.V.P: 120€
LLAVE CARRACA MICRO 1/4"

	 0,45 Kg
 350 rpm	
 29 Nm	



Ref: 2032038

AR-2502 P.V.P: 91€
LLAVE CARRACA 3/8"

	 0,55 Kg
 250 rpm	
 27 Nm	



Ref: 2032046



AR-2504 P.V.P: 73€
LLAVE CARRACA 1/2"

	 1,12 Kg
 150 rpm	
 68 Nm	



Ref: 2032042

AR-2407AK P.V.P: 165€
LLAVE CARRACA 3/8" KIT

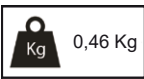
	
 300 rpm	
 30 Nm	
	
 0,46 Kg	

cuadradillo para insertar puntas de 1/4"



Ref: 2032034

AR-2504K P.V.P: 96€
LLAVE CARRACA KIT 1/2"

	
9, 10, 11, 13, 14, 17, 19mm	

Incluye:
articulacion de impacto 1/2"
alargo de 75mm.
porta puntas para puntas de 1/4"

Ref: 2032043

AR-9537J P.V.P: 409€
SUPER CARRACA DE IMPACTO DE 1/2"

 7000 rpm	
 244 Nm	
 1,80 Kg	
	

2 niveles de apriete

Ref: 2032030

AR-3001
TALADRO 3/8"

P.V.P: 75€



Ref: 2032072

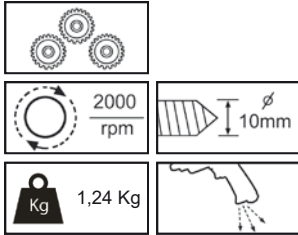

AR-3001C
TALADRO 3/8"

P.V.P: 92€

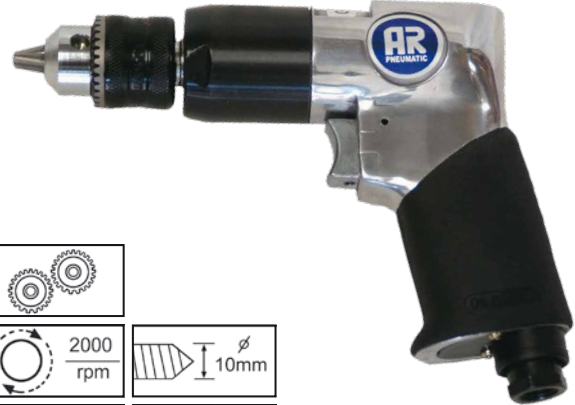

Ref: 2032071

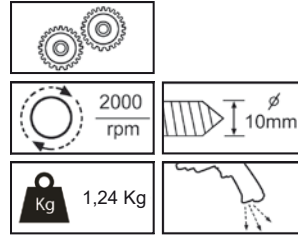

AR-3002
TALADRO REVERSIBLE 3/8"

P.V.P: 79€

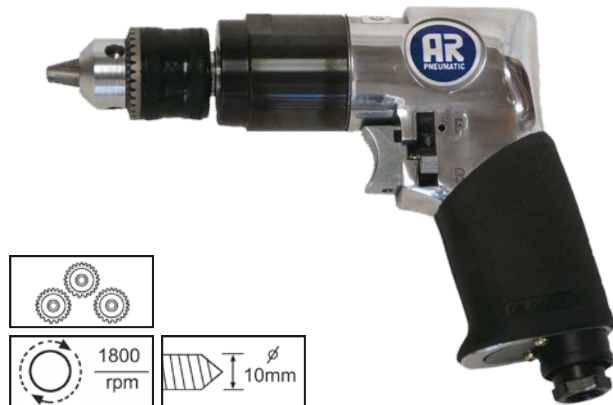

Ref: 2032073

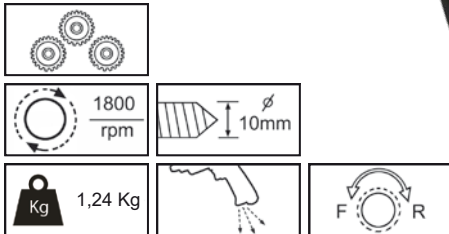

AR-3002B
TALADRO REV. 3/8" PORTABROCAS AUTOM.

P.V.P: 81€

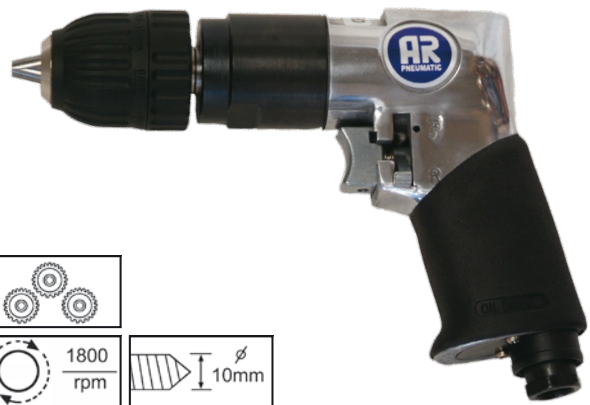

Ref: 2032084

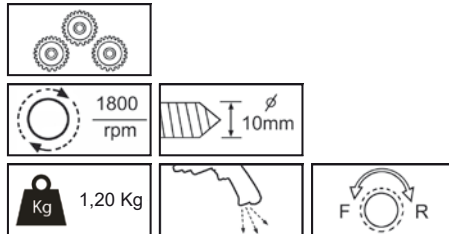

AR-3002C
TALADRO 3/8" INDUSTRIAL

P.V.P: 199€



Ref: 2032076

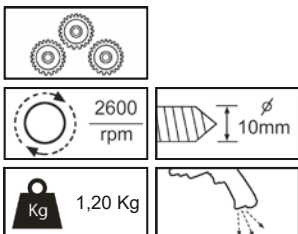

AR-3010
TALADRO 1/2"

P.V.P: 153€

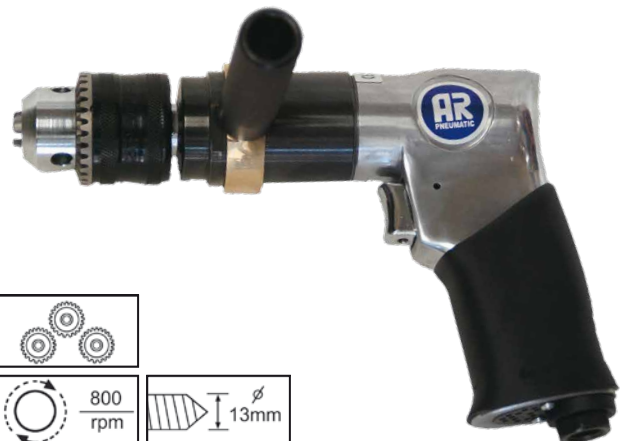

Ref: 2032074

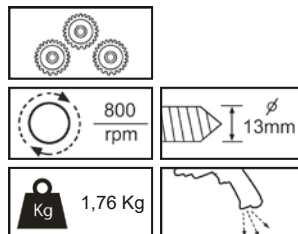

AR-3011 P.V.P: 155€
TALADRO REVERSIBLE 1/2"



Ref: 2032075

	 750 rpm	 13mm
 1,76 Kg		 F R

AR-3018 P.V.P: 212€
TALADRO REVERSIBLE 1/2"



Ref: 2032070

	 750 rpm	 13mm
 1,58 Kg		 F R

AR-3006 P.V.P: 142€
TALADRO ACODADO 3/8"



Ref: 2032079

	 1900 rpm	 10mm
	 1,00 Kg	

AR-3007 P.V.P: 149€
TALADRO ACODADO REV. 3/8"



Ref: 2032080

	 1800 rpm	 10mm	
 1,40 Kg	 F R		

AR-3009 P.V.P: 87€
TALADRO RECTO 3/8"



Ref: 2032081

	 2500 rpm	 10mm
	 1,00 Kg	

AR-3501BM P.V.P: 145€
MINI LIJADORA MOTAS ORBITAL VELCRO



Ref: 2032122

- 30mm ϕ
- 7500 rpm
- 3mm
- 0,63 Kg

AR-3501AM P.V.P: 153€
MINI LIJADORA ROTORBITAL VELCRO



Ref: 2032123

- 50mm ϕ
- 7000 rpm
- 3mm
- 0,75 Kg

Accesorio opcional: plato de 75mm
Ref: AS-3501AM-75 - P.V.P: 28€

AR-3502 P.V.P: 76€
LIJADORA ALTA VELOCIDAD



Ref: 2032111

- 75, 112, 140 mm ϕ
- 18000 rpm
- 1,20 Kg

AR-3505V P.V.P: 99€
LIJADORA ROTORBITAL ADHESIVO



Ref: 2032112

- 150mm ϕ
- 10mm
- 10000 rpm
- 1,90 Kg

AR-3518 P.V.P: 189€
LIJADORA ORBITAL



Ref: 2032121

- 8000 rpm
- 150mm \times 75mm
- 5 mm
- 1,15 Kg

AR-3519V P.V.P: 199€
LIJADORA ORBITAL ASPIRACIÓN



Ref: 2032118

- 8000 rpm
- 150mm \times 75mm
- 5 mm
- 1,20 Kg

AR-3520V P.V.P: 256€
LIJADORA ROTORBITAL ASPIRACIÓN ADHESIVO

AR-3520H P.V.P: 256€
LIJADORA ROTORBITAL ASPIRACIÓN VELCRO



Ref: 2032120

- 10000 rpm
- 150mm ϕ
- 5mm
- 1,70 Kg

AB-3580A (plato de 6 agujeros) P.V.P: 182€
LIJADORA ROTORBITAL 5mm.

Ref: 2035127

AB-3580B (plato de 6 agujeros) P.V.P: 182€
LIJADORA ROTORBITAL 2,5mm.

Ref: 2035128

AB-3580B



Ref: 2035128

- 12000 rpm
- 150mm ϕ
- 5mm
- 0,81 Kg
- 2,5mm

AB-3580A o AB-3580B P.V.P: 207€
CON PLATO DE 15 AGUJEROS

AR-3524V P.V.P: 265€
LIJADORA ROTORBITAL PROFESIONAL LIGERA ADHESIVO

AR-3524H P.V.P: 265€
LIJADORA ROTORBITAL PROFESIONAL LIGERA VELCRO

10000 rpm
Kg 0,86 Kg
150mm
Ref: 2032150



AR-3526V P.V.P: 319€
LIJADORA ROTORBITAL PROFESIONAL LIGERA ASPIRACIÓN ADHESIVO

AR-3526H P.V.P: 319€
LIJADORA ROTORBITAL PROFESIONAL LIGERA ASPIRACIÓN VELCRO

10000 rpm
Kg 0,88 Kg
150mm
Ref: 2032119



AR-4014 P.V.P: 182€
LIJADORA ANGULAR

4500 rpm
175mm
Kg 2,18 Kg
Ref: 2032115



AR-4022 P.V.P: 310€
LIJADORA DE RODILLO

3500 rpm
115mm
Kg 1,00 Kg
Incluye cepillo grueso y adaptador
Ref: 2032129



AR-7001 P.V.P: 142€
LIJADORA DE BANDA

330mm
10mm
10000 rpm
Kg 0,80 Kg
Ref: 2032116

*nueva lija para puntos de soldadura disponible en accesorios (grano 40 y grano 60)



AR-7003 P.V.P: 244€
LIJADORA DE BANDA

520mm
20mm
16000 rpm
Kg 1,10 Kg
Ref: 2032117



AR-1049AD P.V.P: 247€
LIJADORA / AMOLADORA ANGULAR 2"

15000 rpm
Kg 0,80 Kg
50mm
Máquina ligera y robusta para trabajos industriales
Ref: 2032108



AB-3580AC P.V.P: 210€
LIMPIADORA DE TAPIZADOS ROTORBITAL

con cepillo especial para la limpieza de tapizados y moquetas.
Ref: 2035129

AP0001254 P.V.P: 47€
CEPILLO DE RECAMBIO 0,5 mm



AR-T-825K	P.V.P: 196€
MINI PULIDORA KIT CON REGULADOR DE VELOCIDAD	
 75mm	
 600-2200 rpm	
	
 0,90 Kg	
Ref: 2032124	

AR-T-825K-COMPLETA	P.V.P: 218€
AR-T-825K CON EXTRAS PARA EL PULIDO DE ÓPTICAS	
	
Ref: 2032124 (completa)	

AR-4015	P.V.P: 189€
PULIDORA ANGULAR	
 175mm	
 2500 rpm	
	
 2,10 Kg	
Ref: 2032131	





AR-4502	P.V.P: 51€
MINI AMOLADORA RECTA	
 6mm	
 0,57 Kg	
	
 22000 rpm	
Ref: 2032135	

AR-4502K	P.V.P: 70€
MINI AMOLADORA RECTA KIT	
Ref: 2032136	
DP-5511S	P.V.P: 48€
MINI AMOLADORA RECTA KIT	
Ref: 2035138	

 3mm	
 6mm	
	
	
Ref: 2035138	

AR-1049AD	P.V.P: 247€
LIJADORA / AMOLADORA ANGULAR 2"	
 15000 rpm	
 0,80 Kg	
	
 50mm	
Máquina ligera y robusta para trabajos industriales	
Ref: 2032108	

AR-4503	P.V.P: 55€
MINI AMOLADORA RECTA	
 6mm	
 0,32 Kg	
 25000 rpm	
	
Ref: 2032138	

AR-4504	P.V.P: 89€
MINI AMOLADORA ANGULAR	
 6mm	
 0,46 Kg	
 25000 rpm	
	
Ref: 2032137	

AB-5507	P.V.P: 75€
MINI AMOLADORA INDUSTRIAL	
 6mm	
 3mm	
 0,42 Kg	
 22000 rpm	
Ref: 2035137	

AR-4528	P.V.P: 99€
MINI AMOLADORA ANGULAR	
 6mm	
 0,52 Kg	
 22000 rpm	
	
Ref: 2032109	

AR-4009 P.V.P: 189€
AMOLADORA ANGULAR 5"

22mm | 125mm
Kg 1,85 Kg
12000 rpm



Ref: 2032133

AR-4011 P.V.P: 360€
AMOLADORA ANGULAR 7"

175mm
Kg 3,20 Kg
7000 rpm



Ref: 2032134

AR-4505S P.V.P: 102€
MINI AMOLADORA RECTA

6mm | 4000 rpm
Kg 0,70 Kg



Ref: 2032140

AR-MG-121N P.V.P: 210€
MINI AMOLADORA ANGULAR

3mm | 52500 rpm
Kg 0,12 Kg



Ref: 2032148

AR-4509 P.V.P: 106€
MICRO AMOLADORA RECTA
Ref: 2032139

3mm | 54000 rpm



DP-5520S P.V.P: 55€
MICRO AMOLADORA RECTA
Ref: 2035139

3mm | 54000 rpm



AR-4511 P.V.P: 136€
MICRO AMOLADORA RECTA
Ref: 2032147

3mm | 70000 rpm



AR-4517K P.V.P: 176€
MINI AMOLADORA ANGULAR KIT

EL KIT CONTIENE:
1 mini amoladora AR-4517
8 discos de lija
2 platos de lijadora
10 piedras de desbrabar
9 tubos de lija
3 adaptadores de tubo
3 cepillos de lija

3mm | 6mm | 18000 rpm

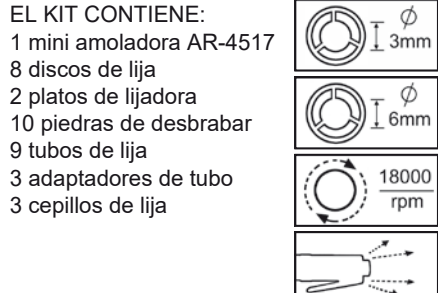



AR-5011K

P.V.P: 125€

ATORNILLADOR PISTOLA

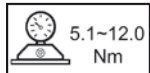
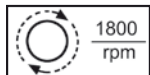
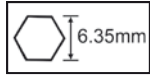

Ref: 2032091



AR-5010

P.V.P: 132€

ATORNILLADOR PISTOLA



Ref: 2032092

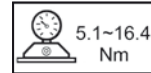
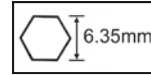

AR-5011C

P.V.P: 169€

ATORNILLADOR PISTOLA PROFESIONAL



Ref: 2032093

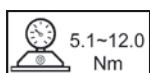
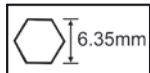

AR-5010C

P.V.P: 179€

ATORNILLADOR PISTOLA PROFESIONAL



Ref: 2032094

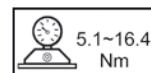
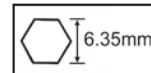

AR-5020

P.V.P: 350€

ATORNILLADOR PISTOLA REGULABLE



Ref: 2032103

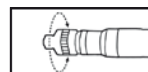
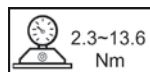
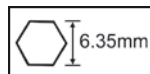

AR-5019

P.V.P: 392€

ATORNILLADOR PISTOLA REGULABLE



Ref: 2032101

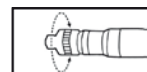
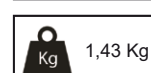
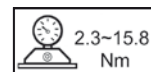
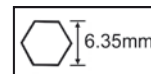

AR-OP-406LN

ATORNILLADOR PISTOLA IMPACTO

P.V.P: 199€

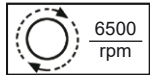
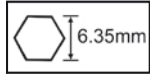

Ref: 2032104

AR-5009

ATORNILLADOR RECTO

P.V.P: 139€

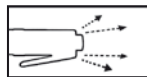
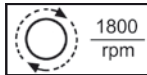
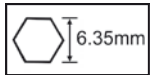

Ref: 2032098

AR-5008

ATORNILLADOR RECTO

P.V.P: 148€

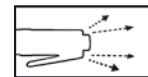
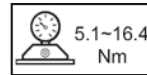
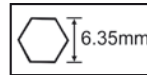

Ref: 2032099

AR-5004K

ATORNILLADOR RECTO KIT

P.V.P: 152€

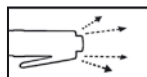
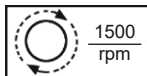
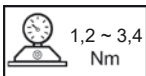
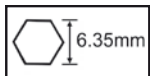

Ref: 2032097

AR-0302L

ATORNILLADOR ACODADO

P.V.P: 239€

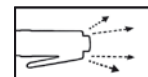
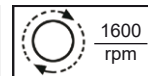
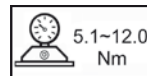
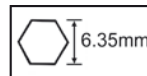

Ref: 2032102

AR-5502H P.V.P: 62€
MARTILLO CINCELADOR



65mm
3000 gpm
1,50 Kg

Ref: 2032021

AR-5503H Descatalogado
MARTILLO CINCELADOR LARGO



2200 gpm
90mm
2,00 Kg

Ref: 2032023

AR-5502HK P.V.P: 109€
MARTILLO CINCELADOR KIT

DP-5506HK P.V.P: 55€
MARTILLO CINCELADOR KIT

Ref: 2032022
Ref: 2031013



130mm 10 mm
Ref: 2032022

AR-5503HK Descatalogado
MARTILLO CINCELADOR LARGO KIT



175mm 10 mm
Ref: 2032024

AR-5511HK P.V.P: 169€
MARTILLO CINCELADOR PROFESIONAL



250mm 10 mm
90mm
2100 gpm
Ref: 2032027

AR-7004NS P.V.P: 328€
ESCARIADOR DE AGUJAS / CINCELADOR



180mm 12.7 mm
19 PCS
4000 gpm
2,70 Kg
Ref: 2032031

AR-4001 P.V.P: 51€
MINI CORTADORA DE DISCO

9mm 75mm
Kg 0,80 Kg

22000 rpm

2.2mm

Ref: 2032151



AR-1518B P.V.P: 245€
CORTADORA 4"

100mm Kg 1,35 Kg

14000 rpm

2.2mm

Ref: 2032149



AR-6506 P.V.P: 108€
CORTADORA

2.6

1.5mm 2.0mm

Kg 1,10 Kg

Ref: 2032152



AR-6509 P.V.P: 112€
SIERRA DE VAIVÉN

9000 spm

10mm

Kg 0,63 Kg

Ref: 2032153



AR-6509K P.V.P: 152€
SIERRA DE VAIVÉN KIT

9000 spm

10mm

Kg 0,63 Kg

Ref: 2032154



AR-6511K P.V.P: 210€
SIERRA DE VAIVÉN PROFESIONAL

9000 spm

10mm

Kg 0,80 Kg

Ref: 2032156



AR-109 P.V.P: 109€
TIJERA DE PODAR

Kg 0,65 Kg

Ref: 2032207



● Corte máximo 20 mm.

AR-6504 P.V.P: 112€
CIZALLA PISTOLA

1.2mm 1.5mm

2200 bpm

Kg 1,10 Kg

Ref: 2032155



AR-7503	P.V.P: 141€	
REMACHADORA (2,4 a 4,8)		
alum. ø 2,0		alum. ø 4,8
alum. ø 4,8		acero ø 2,0
acero ø 2,0		acero ø 3,2
acero ø 3,2		a. inox. ø 2,0
a. inox. ø 2,0		a. inox. ø 4,0
a. inox. ø 4,0		alum. ø 2,0
alum. ø 2,0		acero ø 4,8
acero ø 4,8		a. inox. ø 2,0
a. inox. ø 2,0		acero ø 4,8
acero ø 4,8		Kg 1,46 Kg



Ref: 2032161

AB-7503A	P.V.P: 148€	
REMACHADORA (4,8 a 6,4)		
alum. ø 4,8		acero ø 4,8
alum. ø 6,4		acero ø 6,4
acero ø 4,8		a. inox. ø 4,8
acero ø 6,4		acero ø 6
a. inox. ø 4,8		Kg 1,80 Kg
a. inox. ø 4,8		



Ref: 2032176

AR-7503K	P.V.P: 182€
REMACHADORA EN KIT (2,4 a 4,8)	
Ref: 2032162	
DP-6071	P.V.P: 135€
REMACHADORA EN KIT (2,4 a 4,8)	
Ref: 2035161	



AR-7505	P.V.P: 92€					
REMACHADORA (2,4 a 4,8)						
alum. ø 2,0		acero ø 2,0		a. inox. ø 2,0		alum. ø 2,0
alum. ø 4,8		acero ø 3,2		a. inox. ø 2,4		acero ø 4,0
a. inox. ø 2,0		acero ø 2,4	Kg 1,46 Kg			
acero ø 2,4						



Ref: 2032171

AR-JO-5000-BM	P.V.P: 640€	
REMACHADORA PROFESIONAL 6,4mm		
alum. ø 3,2		alum. ø 6,4
alum. ø 6,4		acero ø 3,2
acero ø 3,2		acero ø 6,4
acero ø 6,4		a. inox. ø 3,2
a. inox. ø 3,2		a. inox. ø 6,4
a. inox. ø 6,4		alum. ø 3,2
alum. ø 3,2		acero ø 6,4
acero ø 6,4		a. inox. ø 3,2
a. inox. ø 3,2		acero ø 6,4
acero ø 6,4		estructural ø 4,8
estructural ø 4,8		estructural ø 6,4
estructural ø 6,4		Kg 2,45 Kg



Ref: 2032177

AR-7526A	P.V.P: 699€			
REMACHADORA DE TUERCAS				
 300 rpm		M6 M8 M10		Kg 1,30 Kg
		M5 (OPCIONAL)		



Ref: 2032167

AR-7501 P.V.P: 237€
QUITAPUNTOS DE SOLDADURA



2000 rpm

6,5mm no incluida

8mm

1,35 Kg

Ref: 2032163

AR-7501K P.V.P: 318€
QUITAPUNTOS DE SOLDADURA KIT



Ref: 2032164

AR-7501H P.V.P: 318€
QUITAPUNTOS DE SOLDADURA CON ARCO DE 60mm. (AVANCE AUTOMÁTICO)



6,5mm no incluida

8mm

2,02 Kg

2000 rpm

Ref: 2032298

AR-DOAR-169A P.V.P: 216€
DESABOLLADOR NEUMÁTICO



diametro ventosas
75mm - 100mm - 125mm

Ref: 2032208

AR-7502H-50 P.V.P: 49€
ARCO OPCIONAL DE 150mm. PARA AR-7501H



Ref: 2032287

AR-7508A P.V.P: 154€
DOBLADORA PERFORADORA



12mm I 1.4mm

1.4mm

ø 8mm

1,30 Kg

Ref: 2032165

AR-6505A P.V.P: 153€
SACALUNAS



20000 bpm

3°

1,20 Kg

incluye 1 cuchilla

Ref: 2032166

AR-6505D P.V.P: 294€
SACALUNAS PROFESIONAL



3°

20000 bpm

1,20 Kg

Ref: 2032157

ARP-630 P.V.P: 179€
CLAVADORA (clavo de 0,6 mm.)



Ref: 2033630

ARP-830 P.V.P: 189€
CLAVADORA (clavo de 0,8 mm.)



Ref: 2033830

ARP-840 P.V.P: 198€
CLAVADORA (clavo de 0,8 mm.)



Ref: 2033840

ARN-1230 P.V.P: 130€
CLAVADORA (clavo de 1,2 mm.)



Ref: 2033123

ARN-1250B P.V.P: 162€
CLAVADORA (clavo de 1,2 mm.)



Ref: 2033125

DP-6206/F50 P.V.P: 69€
CLAVADORA (clavo de 1,2 mm.)





Ref: 2035126

ARN-1650B

P.V.P: 171€

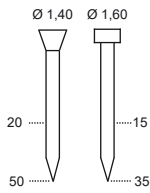
CLAVADORA (clavo de acero 1,6mm.)



Ref: 20331650-B



DP-6218/816

P.V.P: 78€

GRAPADORA (línea 80)

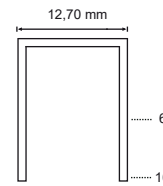

Ref: 2035816



ART-2264

P.V.P: 325€

CLAVADORA (clavo de T 2,2mm.)

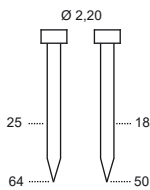

Ref: 2033226



ARCF-15B

P.V.P: 418€

GRAPADORA COARRUGADA

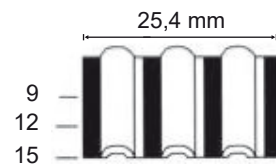

Ref: 2033015



AR-6007 P.V.P: 39€
PISTOLA ANTIGRAVILLA

Ref: 2032187

AB-6006 P.V.P: 42€
PISTOLA DE PETROLEAR

800 C. C.

Ref: 2032188

AR-6010 P.V.P: 54€
ASPIRADORA - SOPLADORA

Ref: 2032181

AR-9171 P.V.P: 50€
PISTOLA ARENADORA

Ref: 2032182

AR-6016 P.V.P: 130€
ARENADORA

*arena no incluida
**grosor máximo de arena 0,5mm.

Ref: 2032184

AR-9001 P.V.P: 10€
PISTOLA SOPLADORA

Ref: 2032183

AB-9002 P.V.P: 11€
SOPLADORA 100mm.

Ref: 2032185

AR-9003 P.V.P: 9€
SOPLADORA 100mm. Ref: 2032186

AR-9003B P.V.P: 12€
SOPLADORA 250mm. Ref: 2032202

AR-9012 P.V.P: 17€
SOPLADORA EXTENSIBLE 265~390mm.

Ref: 2032221

AR-9011R P.V.P: 19€
SOPLADORA GRAN VOLUMEN

Ref: 2032204

AR-9033A P.V.P: 9€
SOPLADOR BOLÍGRAFO

Serie 24 - Ref: 2032200
Serie 26 - Ref: 2032200-A

ST-24504-1 P.V.P: 84€
REPOSICIONADOR FRENOS NEUMÁTICO

Ref: ST-24504-1

AR-6519 P.V.P: 84€
PISTOLA PARA SALCHICHAS



Ref: 2032360



AR-6004 P.V.P: 54€
PISTOLA SILICONA DE CARTUCHO



Ref: 2032189



AR-6001 P.V.P: 59€
PISTOLA ENGRASADORA



Ref: 2032190



AR-6003 P.V.P: 76€
PISTOLA ENGRASADORA KIT
(manual y neumática)



Ref: 2032191





DP-1702 P.V.P: 24€
PISTOLA DE ESPUMA POLIURETANO





Ref: 2035083

AR-SG-4014A P.V.P: 120€
PISTOLA DE PINTAR



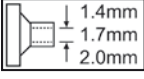

Ref: 2032158 - boquilla de 1,4
Ref: 2032158A - boquilla de 1,7
Ref: 2032158B - boquilla de 2,0

AR-SG-4008A P.V.P: 120€
PISTOLA DE PINTAR RETOQUES

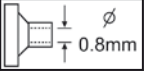

Ref: 2032159

DP-6303A P.V.P: 55€
PISTOLA DE PINTAR HVLP



Ref: 2035159A - boquilla de 1,4
Ref: 2035159B - boquilla de 1,7
Ref: 2035159C - boquilla de 2,0

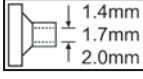

AR-6022

PISTOLA DE LAVADO CICLÓN BLUE

P.V.P: 175€

MENOS PRESIÓN DE TRABAJO

el ciclón blue funciona con solo 4,5 bares, mientras los modelos anteriores necesitan 6

Incorpora cepillo extraíble para limpieza de superficies



Nuevo sistema de cánula protegida y de mayor duración.



Articulación incorporada



Regulación de presión del aire



Ref: 2032362

AB-701

KIT DE ASPIRACIÓN Y SECADO

P.V.P: 79€

(accesorio sin pistola)



Con 4 adaptadores para conectar con la mayoría de aspiradores

Ref: 2032353

AB-702

PISTOLA DE LIMPIEZA PARA ASPIRADOR (SIN DEPÓSITO)

P.V.P: 190€



Ref: 2032358

AR-6023

PISTOLA ESPUMA

P.V.P: 142€

Articulación incorporada
Regulador de presión del aire



Ref: 2032363



Nuevo sistema de boquilla para mayor efectividad

AB-JH-502

P.V.P: 194€*

ASPIRADOR DE 1 MOTOR (1300W)

35 LITROS DE CAPACIDAD
APTO PARA SÓLIDOS
Y LÍQUIDOS.

Medidas: 74x42x42cm
Voltaje: 220V/50Hz
Potencia: 1300W
Capacidad: 35L
Peso neto: 7,44Kg
Sonido: <80dB
Cable: 5m



Ref. 2032278C

AB-JH-601S

P.V.P: 499€*

ASPIRADOR INDUSTRIAL DE 3 MOTORES (4800W)

80 LITROS DE CAPACIDAD
APTO PARA SÓLIDOS
Y LÍQUIDOS.

Medidas: 83x58x54cm
Voltaje: 220V/50Hz
Potencia: 4800W
Capacidad: 80L
Peso neto: 25,2Kg
Incluye filtro HEPA
Sonido: <80dB
Cable: 5m



basculante



Ref. 2032278B

2032351

P.V.P: 160€

ESTUFA INFRARROJOS DE ONDA CORTA

Los infrarrojos de onda corta son en muchos aspectos diferentes de los métodos de secado de pintura tradicionales ya que penetran en la superficie de la capa de pintura y calientan el interior, secándolo con más rapidez y eficiencia.

Este método de secado de interior a exterior es más eficaz ya que genera un secado más uniforme y rápido.

La utilización de infrarrojos de onda corta reduce el tiempo de secado y mejora la calidad del acabado de la pintura

230V
1.500W
50HZ

- Referencia estufa: 2032351
- Referencia trípode: 2032354

*incluye anclaje a la pared



*por solo 10€ mas llévase el trípode.

Capa	Infrarrojos onda corta	Cabina / Horno	Secado al aire
Masilla	8-10 min.	10-20 min.	30-60 min.
Capa Base (Aparejo)	8-12 min.	30-45 min.	240 min.
Capa Superior (Color)	8-10 min.	30-45 min.	240 min.
Barniz	8-12 min.	30-45 min.	240 min.

*tiempos aproximados

MODELO 6

MINI SOLDADOR DE PLÁSTICOS

P.V.P: 396*

Ideal para realizar todo tipo de reparaciones sobre cualquier superficie y material plástico. Su soldador, con temperatura variable a voluntad, lo hace perfecto para cualquier reparación.

Tanto el soldador como el regulador de temperatura son fácilmente accesibles para el operario, permitiendo ajustar la temperatura más conveniente en cada momento de la reparación. De fácil transporte, incorpora un práctico y resistente maletín, con sus respectivos accesorios. Todo ello lo convierte en el soldador más moderno y práctico del mercado para la reparación de plásticos.

Contiene:

- 1 soldador
- 1 puntilla soldadura estándar
- 1 puntilla soldadura redonda
- 1 malla metálica de refuerzo
- 1 cepillo metálico
- 1 soporte soldador
- 1 DVD tutorial
- 15 varillas poliuretano
- 15 varillas fibra flexible plana
- 15 varillas polipropileno
- 15 varillas ABS
- 15 varillas polietileno
- 15 varillas TPO (termoplástico)
- 15 varillas nylon
- 4 varillas policarbonato



Ref: 5600HT

86090039

EQUIPO SOLDADOR NANOPLASTIC

P.V.P: 126€*

NANOPLASTIC stapler es un kit profesional completo para reparar todo tipo de plásticos en automoción

3 posiciones diferentes de trabajo

REPARA:

- fácil
- rápido
- seguro
- resistente
- efectivo



NOVEDAD: Nuevas referencias

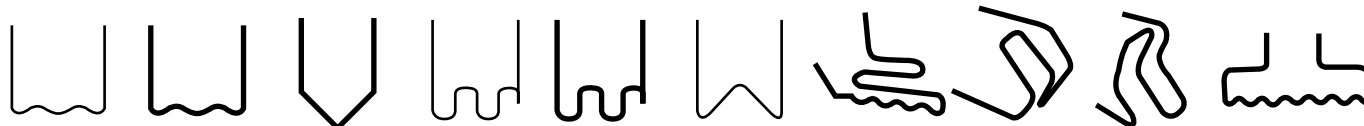

Forma U - GF16 Ø 0,6 mm. Ref: 86090041 OFERTA 7,20€	Forma U - GF18 Ø 0,8 mm. Ref: 86090042 OFERTA 7,20€	Forma V - GF26 Ø 0,8 mm. Ref: 86090045 OFERTA 7,20€	Forma S - GF28 Ø 0,6 mm. Ref: 86090043 OFERTA 7,20€	Forma S - GF38 Ø 0,8 mm. Ref: 86090044 OFERTA 7,20€	Forma M Ø 0,7 mm. Ref: 86090074 OFERTA 7,20€	Extra reforzada Ø 0,8 mm. Ref: 86090060 OFERTA 11€	Forma Doble V Ø 0,8 mm. Ref: 86090061 OFERTA 8,50€	Forma Doble M Ø 0,8 mm. Ref: 86090062 OFERTA 8,50€	Forma T Ø 0,8 mm. Ref: 86090075 OFERTA 8€
---	---	---	---	---	--	--	--	--	---

VIP-756

P.V.P: 269€

JUEGO DE SACABOLLOS ADHESIVO (21 PIEZAS)



Para reparación de chapa en pequeñas abolladuras, granizadas, etc... sin dañar la pintura

Recambios:

2032291 - Tirador de palanca	152€
2032301 - 8 Barras de pegamento adhesivo	15€
2032302 - 9 Setas	21€
2032303 - Pistola de pegamento	18€
2032292 - Rascador de nylon	7€
2032317 - Martillo deslizante	67€

Ref: 2032282

DO-ST36027

P.V.P: 9€

ABRE BOTES DE PLÁSTICO



Ref: 2032218

AAZ-C601

P.V.P: 112€

ABRAZADERA CON APERTURA DE PINZA



Ref: 2032220

ST-22045

P.V.P: 86€

ALICATE CON GRAPAS (11 PIEZAS)



Ref: 2032285

Alicate con grapas para sujetar la chapa durante el proceso de soldado, doblado, etc...

Para un rango de sujeción de 0 a 5 mm
Incluye 10 grapas reutilizables.

Material: Acero Cr-Mo

grapa de acero

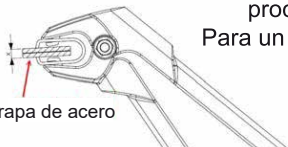

ST-22045-3

P.V.P: 1,80€/u

GRAPA RECAMBIO

Ref: 2032286

HSA0014

P.V.P: 30€

JUEGO DE CUTTERS METÁLICOS (27 PIEZAS)



Ref: 2032409

Cuchillas:

Ref: 2032409A - 10 cuchillas - trapezoidales	5€
Ref: 2032409B - 10 cuchillas - 12mm	4€
Ref: 2032409C - 10 cuchillas - 16mm	4€
Ref: 2032409D - 10 cuchillas - 16mm (53°)	5€
Ref: 2032409E - 10 cuchillas - 20 mm	4€

UH6KS

P.V.P: 79€

JUEGO DE 6 TACOS DE LIJADO

POSICIÓN DEL TACO EN LA MALETA:



TACO 1 - Ref: 2032439 (convexo más pronunciado)

TACO 2 - Ref: EH530 (azul)

TACO 3 - Ref: 2032446 (convexo)

TACO 4 - Ref: 2032437 (cóncavo)

TACO 5 - Ref: 2032402 (plano)

TACO 6 - Ref: 2032436 (cóncavo más pronunciado)



Ref: 2032401

ZI-04

P.V.P: 239€

CABALLETE PARA PLANCHA



Dimensiones 110x100 cm
Capacidad: 140Kg.
Ajustable 180°
Peso: 14,5Kg.



Ref: 2032178

AR-AAU-9020C

P.V.P: 15€

VENTOSA MULTIFUNCIÓN (20kg)



Ref: 2032180

AR-9005B

P.V.P: 19€

VENTOSA INDIVIDUAL (40kg)



Ref: 2032172

AR-9005A

P.V.P: 92€

JUEGO DE VENTOSAS KIT (160kg)



Ref: 2032168

FS-616201A
SACAGRAPAS

P.V.P: 9€



FS-715201
SACAGRAPAS PLANO

P.V.P: 10€



FS-617201-6
SACAGRAPAS 6mm.

P.V.P: 8€



FS-613201L
SACAGRAPAS EXTRALARGO 500mm.

P.V.P: 12€



ST-22002
SACAGRAPAS DE NYLON (5 PIEZAS)

Consultar



Ref: ST-22002

ST-22010
DESABOLLADOR - 12 PIEZAS

P.V.P: 129€

- 1 Tirador de abolladuras
- 5 Ganchos: 6x170mm, 6x120mm, 6x120mm, 6x200mm, 3x120mm.
- 2 Tubos ø 22,5 x 590mmL, ø22,5 x 200mmL.
- 1 Martillo de 10 lb hierro - 1 Tubo de dos agujeros ø 29x40mm.
- 1 Cadena y gancho - 1 Tuerca hexagonal 29mm.



Ref: ST-22010

ABRAZADERAS UNIVERSALES DE BOLA
ABRAZADERAS DE ACERO INOXIDABLE

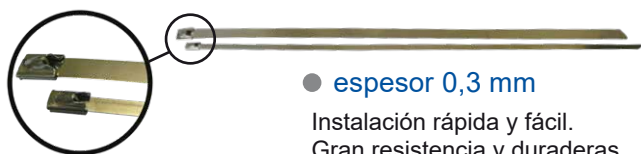

- **espesor 0,3 mm**
- Instalación rápida y fácil.
- Gran resistencia y duraderas.

Referencia	largo (mm.)	ancho (mm.)	P.V.P. 50 unidades
AB1001	200	4,6	20,00 €
AB1002	360	4,6	22,00 €
AB1003	520	4,6	23,00 €
AB2001	200	7,9	20,00 €
AB2002	360	7,9	24,00 €
AB2003	520	7,9	32,00 €

ALICATE TENSOR DE ABRAZADERAS
PARA BRIDAS DE ACERO INOXIDABLE

P.V.P: 86€



El módulo semiautomático permite tensar y cortar las abrazaderas de acero inoxidable de una manera rápida, cómoda y segura.

Ref: ABTOOL

TW-BT10

P.V.P: 36€

JUEGO TORNILLOS BMW

A: #30(13 caras) B: #31(15 caras) C: #32(16 caras)
D: #33(17 caras) E: #34(18 caras) F: #35(19 caras)
G: #36(20 caras) H: #37(21 caras) I: #38(22 caras)
J: #40(23 caras)



Ref: 2032325

ST-32002

P.V.P: 129€

KIT EXTRACTOR DE TORNILLOS ANTI-ROBO VOLKSWAGEN (VAG)

Contiene:

22 extractores de tornillos:

#51/6PT, #52/7PT, #53/8PT, #54/9PT,
#55/10PT, #56/11PT, #57/18PT,
#58/13PT, #59/14PT, #60/15PT,
#61/16PT, #62/17PT, ABC0/10PT,
ABC1/11PT, ABC2/13PT, ABC3/14PT,
ABC4/15PT, ABC5/16PT, ABC6/17PT,
ABC7/19PT, ABC8/20PT, ABC9/21PT

1 Vaso de aluminio 1/2" de 17 mm.

Material: SCM440



Ref: 2032403

AB4688

P.V.P: 9€

SOPORTE TAPA MOTOR HDI (4 unidades)

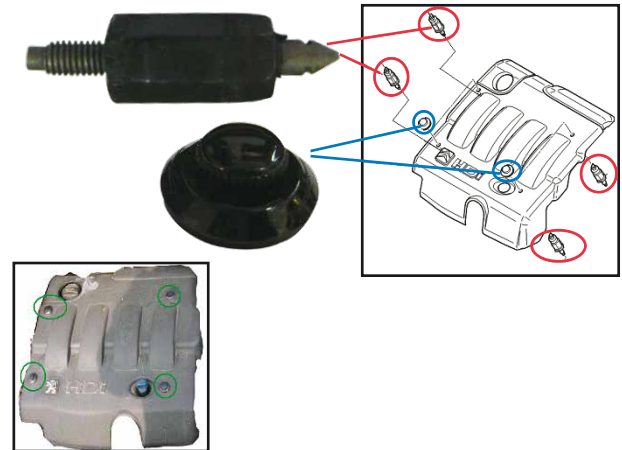

Ref: 20324688

BTA-30PCS

P.V.P: 138€

JUEGO PARA POLEAS DE ALTERNADOR (30 PIEZAS)

Contenido:

- Vaso hex. 22mm x 30mm
- Vaso Ø 28,6mm x 28,1mm
- Vaso hex 22,21mm hex x 32 mm
- Vaso hex. 28mm x H19 x 35mm
- Vaso hex. H28 x H21
- Vaso hex. H17 x H21
- Vaso Ø 35mm con 4 pins
- Vaso hex. 17mm x 35mm x Ø 12,3mm
- Vaso hex. 33 dientes x 15mm
- Vaso hex. 33 dientes x 15mm x 17,5
- Vaso hex. 33 dientes x 15mm
- Vaso hex. 33 dientes x 22mm
- Vaso hex. 33 dientes x 17mm
- Vaso hex. H17 x H19
- Vaso hex. Ø38mm x 17mm
- Punta M10 x 64mm
- 6 puntas hex. 10mm x 75mm
- Punta H10 x 70mm
- Vaso punta 3/8" M10 x 90mm con 31 dientes
- Vaso punta 1/2" H8 x 120mm
- Vaso punta 1/2" M10 x 140mm
- Vaso punta 1/2" M10 x 113mm con 33 dientes
- Vaso punta 1/2 T50 x 113mm con 33 dientes
- Adaptador 1/2" H10
- Punta H10 x 50mm
- Adaptador 17mm hex. 35 mm x Ø 14,8mm
- Vaso 1/4" H10 x 50mm



Ref: 2032274

IA-6378

P.V.P: 70€

ALICATE DE ABRAZADERAS



Alicate especial para regulado de abrazaderas que tienen que ir a un determinado apriete (refrigeración, combustible, etc...) Para usar con dinamométrica.

Ref: 2032284

S-025

P.V.P: 17€

MINI ENGRASADOR 80 ml.



Ref: 2032199

**PORTA PUNTAS DE 10mm. EXTRALARGO
IDEAL PARA ACCEDER A PALIERES**

P.V.P: 40€



800mm.

Ideal para trabajar palieres y lugares donde se tenga difícil acceso.

El portapuntas extralargo permite usar cualquier punta de 10mm con una sola barra!

Fabricado con barra reforzada de 12mm. permite el uso con llave de impacto.

porta puntas 10mm.

1/2"

Ref: 2032295

2032300

P.V.P: 14€

**ADAPTADOR DE
10mm A 3/8" MACHO**



Utilice también cualquier tipo de vaso de 3/8" con el adaptador de vaso para porta puntas extralargo!

Ref: 2032300

QK-1110

P.V.P: 24€

ESTRANGULADOR MANGUITOS

Especificaciones:

Longitud: La abrazadera de la manguera de extensión es de 310mm para ayudar en el trabajo de reparación.

Uso máximo: 25.4 mm

Características:

Detiene el flujo del aceite y evita mangueras perjudiciales. El cuerpo largo ahorra tiempo al usuario para alcanzar y cerrar mangueras y al mismo tiempo evita quemarse. Ajustable para la mayor parte de tipos de mangueras flexibles, en particular para el freno, repostaje o mangueras de sistema de refrigeración.

Instrucciones:

Ajuste la bola móvil y encaje la anchura de manguera, luego atornille la cabeza ajustable.



Ref: 2032259

HU-200

P.V.P: 29€

JERINGA PARA EL LÍQUIDO DE FRENOS (S/200ml.)

- Adecuada para la extracción y el relleno
- Transparente para ver el fluido
- Tapón para evitar el goteo
- Capacidad: 200 ml.



Ref: 2032029

*Para usar con aceite consultar

HU-46008

P.V.P: 64€

JERINGA PARA ACEITE (XL/1,5L.)

- Aplicaciones tales como el aceite de los engranajes y los fluidos diferenciales.
- Adecuada para la extracción y relleno.
- Transparente para ver el fluido.
- Tapón para evitar el goteo
- Cierre rotativo.



Ref: 2032019

CIERRE ROTATIVO

FY-3822

P.V.P: 41€

ALICATE PARA ABRAZADERAS (0~38mm)

Ref: 2032275

FY-5522

P.V.P: 43€

ALICATE PARA ABRAZADERAS (22~55mm.)

Ref: 2032276

Boca con diseño especial para mayor agarre.
Sistema de bloqueo multi-stop
Ideal para la mayoría de abrazaderas de banda



FY-3822 (0~38mm)



FY-5522 (22~55mm)

ST-23053

P.V.P: 121€

LLAVES PARA TENSORES DISTRIBUCIÓN, CORREAS DENTADAS Y POLEAS 12 CARAS (12-13-14-15-16-17-18-19 mm.)



Ref: 2032327

PBK-37PC P.V.P: 215€
REPOSICIONADOR DE FRENOS - 37 PIEZAS



Ref. 2032260

Contiene los reposicionadores de frenos para la mayoría de modelos del mercado y los útiles para su uso.

2032429 P.V.P: 30€
PALANCA PARA LLAVES Y ALICATES



Ref. 2032429

BTA-37K-5 PIEZAS P.V.P: 27€
REPOSICIONADOR DE PISTONES (5 PIEZAS)



Ref. BTA-37K-5 PIEZAS

NUEVOS MODELOS

PA-SFJ-1302 P.V.P: 30€
LLAVE DE FILTRO 305mm. AUTOAJUSTABLE (40-118mm.)



Ref. 2032311

ST-25070B P.V.P: 10€
AUTO TESTER DE 3 A 48V



Ref. ST-25070B

WRT-002 P.V.P: 90€
KIT DE DESPEGAR LUNAS - 4 PIEZAS

- WRT-00204 - 1 Rollo de cable cuadrado (0,6mm x 0,6mm x 50mL.) **37 €**
 - WRT-00203 - 1 Útil pasador de cable **14 €**
 - WRT-00201 - 1 Palanca para lunas **15 €**
 - WRT-00202 - 1 Tirador de cable en T **24 €**
- P.V.P. unitario**



Ref. 2032264

VI-PPS1721

P.V.P: 10€

VASO DE IMPACTO PARA
MERCEDES-BENZ M517 1/2"



Ref: 2032316

TM-0068C

P.V.P: 79€

MULTIPLICADOR DE FUERZA

Salida del movimiento de rotación: 4.800 NM
Velocidad de transacción: 1:64
Cuadradillo: 1"
Dos vasos: 32mm, 33mm.
Camiones, autobuses y otros vehículos pesados



2036015

P.V.P: 1€

DESTORNILLADOR DE
OBUSES



Ref: 2036015

AB-G-2348

P.V.P: 78€

DESTALONADOR DE NEUMÁTICOS



permite despegar neumáticos de la llanta de manera fácil, rápida y segura

Ref: 2036002

AB-G-2320

P.V.P: 266€

KIT MONTAJE Y DESMONTAJE DE NEUMÁTICOS DE CAMIÓN

Incluye:

- palanca para desmontar cubierta
- palanca para montar
- cejilla para sujetar la cubierta al montar.

(lubrificar o enjabonar la zona de contacto para facilitar la operación)



Ref: 2036001

TT-1002

P.V.P: 25€

KIT REPARACIÓN PINCHAZOS (25 PIEZAS)

TT-104S

P.V.P: 4€

RECAMBIOS TIRAS REPARADORAS (25 UNIDADES)

Incluye:

- 1 barrena en T lisa para insertar tira reparadora
- 1 barrena en T de lima
- 20 tiras de 4"
- 2 llaves
- 1 lubricante



TT-105S

P.V.P: 7,50€

RECAMBIO TIRAS REPARACIÓN
DE NEUMÁTICOS PARA
CAMIÓN 20cm (25uds)



2036016

P.V.P: 24€

DESMONTADOR DE LLANTAS
DE ALUMINIO 520mm



Ref: 2036016

203722034

P.V.P: 45€

KIT UNIVERSAL SOPORTE PARA GATO DE FOSO



KIT CAMBIO DE CAMBIO RÁPIDO

P.V.P: 198€

DE UÑAS PARA DESMONTADORA DE NEUMÁTICOS

CONTIENE:

- cambio rápido de uñas
- adaptador para uña de nylon
- adaptador para uña metálica (no incluye uñas)



Ref: 2032420

SOPORTE FIJO

P.V.P: 52€

DE UÑAS PARA DESMONTADORA DE NEUMÁTICOS



Ref: 2032421

UÑAS DE NYLON

P.V.P: 29€/u

PARA DESMONTADORA DE NEUMÁTICOS



Ref: 2032407

AB-G-2339

P.V.P: 178€

TALONADOR DE NEUMÁTICOS INSTANTÁNEO

Permite talonar e inflar neumáticos de manera instantánea

Capacidad: 5 galones
(aproximadamente 19 litros)
Presión de trabajo: 10bar
Presión máxima: 14,9bar
Peso: 12kg



Ref: 2036003



203722002R P.V.P: 11€

21mm
8mm
130mm interior
138mm exterior

Taco compatible con elevadores:
CASCOS - CORGUI - AUTOMAQ
ZIPPO - CONSUL - WEBER

203722003R P.V.P: 13€

24mm
6mm
147mm interior
155mm exterior

Taco compatible con elevadores:
ISTOBAL - VELYEN

203722008 P.V.P: 11€

27mm
10mm
113mm interior
122mm exterior

Taco compatible con elevadores:
WERTHER - OMA - TECALEMIT
ITALGARAGE

203722017 P.V.P: 12€

27mm
35mm
110mm interior
120mm exterior

Taco compatible con elevadores:
- RAVAGLIOLI

203722020 P.V.P: 12€

26mm
10mm
135mm interior
148mm exterior

Taco compatible con elevadores:
RAVAGLIOLI

203722021 P.V.P: 11€

21mm
9mm
87mm interior
100mm exterior

Taco compatible con elevadores:
RAVAGLIOLI - SIRIO - SPACE
COIRO - ASTRA

203722000 P.V.P: 11€

26mm
10mm
110mm interior
122mm exterior

Taco compatible con elevadores:
RAVAGLIOLI - WERTHER - SPACE
SIRIO - ORLANDINO - ASTRA

203722014 P.V.P: 12€

27mm
45mm
136mm interior
145mm exterior

Taco compatible con elevadores:
- RAVAGLIOLI

203722018

P.V.P: 12€

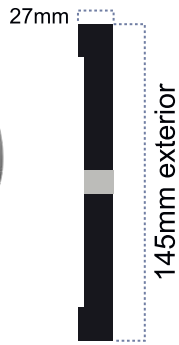

Taco compatible con elevadores:
OMCN - ROGEN

203722024

P.V.P: 12€

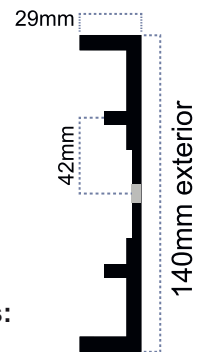

Taco compatible con elevadores:
OMCN - ROGEN

203722006

P.V.P: 11€

DOBLE GROSOR - AGUJEROS PRE-PERFORADOS

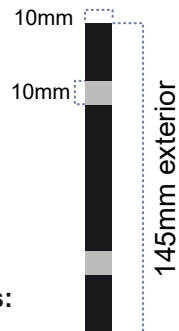

Taco compatible con elevadores:
VELYEN - ISTOBAL

203722007

P.V.P: 11€

AGUJERO PRE-PERFORADO

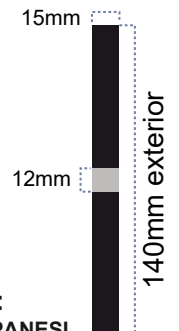

Taco compatible con elevadores:
WETHER - OMA - TECALEMIT - BRADBURY - SPANESI

203722013

P.V.P: 12€

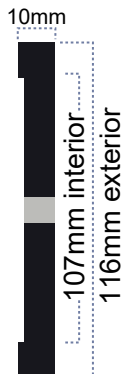

Taco compatible con elevadores:
CORGHI - LAUNCH

203722022

P.V.P: 13€

TACO OCTOGONAL

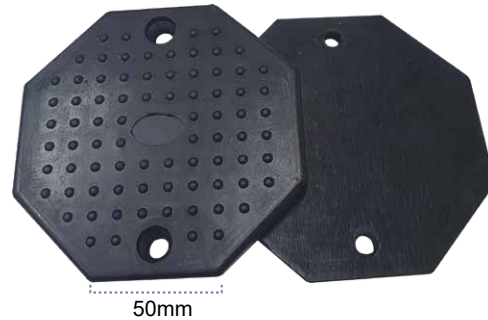

Taco compatible con elevadores:
SPACE - RP TOOLS - Y OTROS
ELEVADORES DE IMPORTACIÓN

203722005

P.V.P: 13€

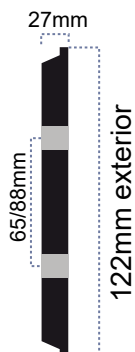

Taco compatible con elevadores:
STENHOJ - NUSSBAUM - OTROS

TACO PARA ELEVADOR DE TIJERA

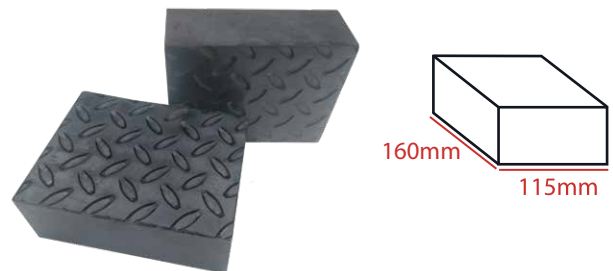

2032404	TACO DE 20mm	P.V.P: 8€
2032406	TACO DE 40mm	P.V.P: 12€
2032408	TACO DE 60mm	P.V.P: 15€
2032405	TACO DE 80mm	P.V.P: 17€

ST-22003-L

P.V.P: 39€

PALANCA POLIVALENTE 380 mm.



● ángulo regulable

Ref: ST-22003-L

ST-29015

P.V.P: 30€

JUEGO DE 4 PALANCAS

Pala x largo:
6 x 200 mm
9 x 300 mm
11 x 455 mm
11 x 600 mm



Ref: 2032350

WL-5KE1

P.V.P: 5€

MARTILLO DE EMERGENCIA



TRES FUNCIONES:
Corte + linterna + martillo
(pilas no incluidas)

HQ-11050173

P.V.P: 10€

MINI LÁMPARA MAGNÉTICA FLEXIBLE



Flexible



Magnético

Atraiga piezas pequeñas de lugares oscuros con el imán y la luz de led

Imán para pequeñas partes metálicas, tornillos, arandelas, etc....

Ref: 2032198

2034430

P.V.P: 39€

LUZ DE TRABAJO COMPACTA AJUSTABLE

Ultra fina.
Potencia regulable.
Tiempo de funcionamiento:
2,5 a 12 horas según nivel potencia.
Tiempo de carga: 3,5h.
Batería 2200mAh de ion de litio.

Potencia máxima 15W.
935 Lumen.
Base giratoria 360°.
Gancho abatible 180°.
Cargador micro USB.
Imán en base.



Dimensiones 375x40x30mm.

Grosor parte delantera: 9mm.

DO-918

P.V.P: 50€

MALETÍN SURTIDO CON VARIOS COMPARTIMENTOS (300 x 145 x 330mm. / 1,7kg.)

APERTURA CON UNA MANO



ENGANCHE PARA CINTURÓN



Disponibles para llevar al hombro modelo: DO-01 2032020 P.V.P: 6€



DO-918-5 2032319 Separadores P.V.P: 0,70€/u



Ref: 2032018

*Contenido no incluido

TENSORES

DE 0,6 A 5 Kg.

AR-9006A Ref: 2032211

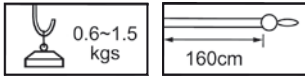

P.V.P 39 €

AR-9006B Ref: 2032212



P.V.P 39 €

AR-9006C Ref: 2032213

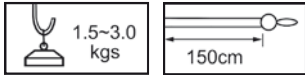

P.V.P 66 €

AR-9006D Ref: 2032214

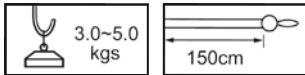

P.V.P 81 €



TENSORES

DE 5 A 15 Kg.

AR-9006E Ref: 2032215

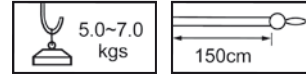

P.V.P 165 €

AR-9006G Ref: 2032216

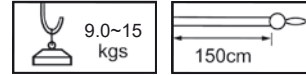

P.V.P 339 €



AS-28H

P.V.P: 14€

SET 4 CINCELES HEX. CORTOS

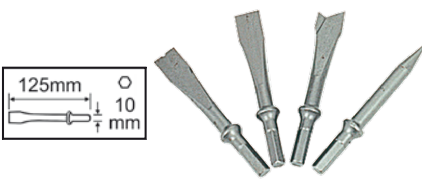

Ref: 2032222

AS-29H

P.V.P: 35€

SET 5 CINCELES HEX. LARGOS

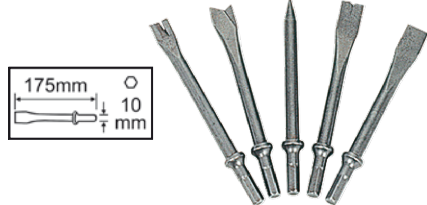

Ref: 2032246

AS-43H

P.V.P: 52€

SET 4 CINCELES HEX. EXTRALARGOS

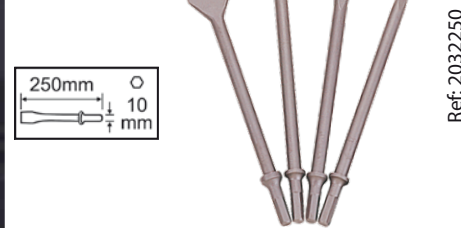

Ref: 2032250

AS-18

P.V.P: 8€

PORTA BROCAS 3/8" CON LLAVE 10mm.

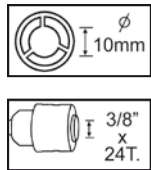

Ref: 2032232

AS-20

P.V.P: 19€

PORTA BROCAS AUTOM. 3/8" 10mm.

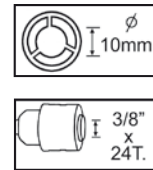

Ref: 2032234

AS-21

P.V.P: 43€

PORTA BROCAS AUTOM. 3/8" 13mm.

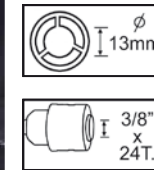

Ref: 2032258

HR-670

REMACHES

Referencia	Ø mm	P.V.P. 10 unidades
HR-670-24RI	2,4 x 8	0,70 €
HR-670-30RI	3,0 x 10	0,80 €
HR-670-40RI	4,0 x 10	1,10 €
HR-670-48RI	4,8 x 15	1,50 €
HR-670-48I564	6,4 x 12	2,50 €



HR-670

TUERCAS REMACHABLES

Referencia	Ø mm	P.V.P. 100 unidades
HR-670-RN3	3	16,00 €
HR-670-RN4	4	18,00 €
HR-670-RN5	5	19,00 €
HR-670-RN6	6	24,00 €
HR-670-RN8	8	32,00 €
HR-670-RN10	10	35,00 €



AS-22A P.V.P: 7€
MINI LUBRIFICADOR ROSCA 1/4"



Ref: 2032242

AS-27 P.V.P: 2€
MUELLE MARTILLO CINCELADOR



Ref: 2032243

AS-26 P.V.P: 19€
CAMBIO RÁPIDO CINCELADOR



Ref: 2032236

AS-37A P.V.P: 6€
BOQUILLA INFLADOR ROSCA 1/4"



Ref: 2032268

AS-37B P.V.P: 2€
BOQUILLA INFLADOR ESPIGA DE 7mm.



Ref: 701225

AS-37C P.V.P: 6,10€
ENCHUFE RÁPIDO PARA INFLADOR (espiga 7mm.) Ref: 701235

AS-37D P.V.P: 6,80€
ENCHUFE RÁPIDO PARA INFLADOR (espiga 8mm.) Ref: 701235A





Doble mordaza para evitar perdidas de aire y fijar bien la boquilla a la valvula

Enchufe rápido para infladores:

- Fácil y rápida conexión con la válvula
- Mono-pieza resistente sin puntos de fractura
- Sistema de doble mordaza

AS-32B P.V.P: 20€
BROCA QUITAPUNTOS 8 mm.



Ref: 2032238

AS-32A P.V.P: 24€
BROCA QUITAPUNTOS 6,5 mm.



Ref: 2032239

AB-G2319 P.V.P: 31€
INFLADOR RUEDAS DIGITAL (PRESIÓN MÁXIMA 15 BARES)



Ref: 2036012

EN-12645 P.V.P: 51€
INFLADOR RUEDAS HOMOLOGADO CON CERTIFICADO DE CALIBRACIÓN (PRESIÓN MÁXIMA 10 BARES)



Ref: 751280

AR-9004 P.V.P: 82€
INFLADOR RUEDAS (PRESIÓN MÁXIMA 15 BARES)



Ref: 2032173

AS-05A P.V.P: 8€
DISCO DE CAUCHO QUITA ADHESIVOS



Ref: 2032690

AS-05C P.V.P: 3,50€
ADAPTADOR DE DISCO



Ref: 2032693

AS-31A P.V.P: 2,70€
SIERRA 24 DIENTES



Ref: 2032558

AS-31B P.V.P: 2,70€
SIERRA 32 DIENTES



Ref: 2032559

AS-33A P.V.P: 14€
CUCHILLA G-57 mm.



Ref: 2032223

AS-33B P.V.P: 28€
CUCHILLA SACALUNAS G-90 mm.



Ref: 2032226

AS-34 P.V.P: 14€
CUCHILLA SACALUNAS G-35 mm.



Ref: 2032224

AS-35 P.V.P: 14€
CUCHILLA SACALUNAS K-30 mm.



Ref: 2032225

AS-36 P.V.P: 15€
CUCH. LIMPIEZA SACALUNAS 8 mm.



Ref: 2032240

AS-39 CUCHILLAS SACALUNAS U

AS-39A 18 mm. Ref: 2032227 P.V.P 20 €



AS-39B 24 mm. Ref: 2032228 P.V.P 25 €



AS-39C 36 mm. Ref: 2032229 P.V.P 26 €



AS-39D 63 mm. Ref: 2032230 P.V.P 29 €



AS-39E 90 mm. Ref: 2032231 P.V.P 32 €



AS-4022 P.V.P: 26€ / u
CEPILLOS

AS-4022B GRUESO Ref: 2032253

AS-4022C MEDIO Ref: 2032254

AS-4022D FINO Ref: 2032255



AS-4022A P.V.P: 29€
ADAPTADOR DISCO



Ref: 2032252

AS-4022E P.V.P: 42€
DISCO DE CAUCHO DENTADO



Ref: 2032256

AS-63A P.V.P: 51€
DISCO DE CORTE 60mm (180 DIENTES)



Ref: 2032694

AR-8814 Descatalogado
ROLLO MANGUERA 8X13X50 m. Ref: 0150031
INTERIOR DE 8mm.



AR-8515A P.V.P: 110€
ROLLO MANGUERA SUPER-FLEXIBLE Ref: 2032105
DE POLÍMERO HÍBRIDO 8x13mm x 50m. (INTERIOR DE 8mm.)

AR-8515B P.V.P: 139€
ROLLO MANGUERA SUPER-FLEXIBLE Ref: 2032106
DE POLÍMERO HÍBRIDO 10x15mm x 50m. (INTERIOR DE 10mm.)

Gran flexibilidad.
Regresa a su forma original.
Superficie suave no daña pintura.
Muy resistente.
Presión de trabajo 300psi/20 bar.
Presión de rotura 950psi/65 bar.
Temperatura de trabajo -40°C/65°C.
Disponible en diámetro 8 y 10mm interior por tramos a medida con conexiones.
También disponible conexiones para Michelin.
*consultar precios según tamaño y conexiones.



ENROLLADORES DE AIRE

AB-10MP

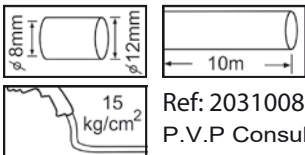

Ref: 2031008
P.V.P Consultar

AXGQ150

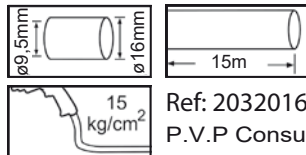

Ref: 2032016
P.V.P Consultar

*rosca 1/4" macho

*rosca 3/8" macho



AR

ESPIRALES DE POLIURETANO CON TERMINALES GIRATORIAS ROSCA MACHO 1/4"

ESPIRAL 5 X 8

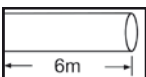

Ref: 2032001
P.V.P 13 €

ESPIRAL 8 X 12

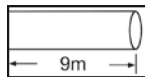

Ref: 2032006
P.V.P 29 €

RECAMBIOS

Ref: 10058 Terminal giratoria 5x8: P.V.P 5 €
Ref: 1006510 Terminal giratoria 6,5x10: P.V.P 6 €
Ref: 100812 Terminal giratoria 8x12: P.V.P 7 €

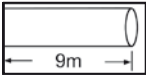

Ref: 2032002
P.V.P 16 €

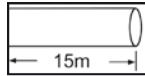

Ref: 2032007
P.V.P 40 €

ESPIRAL 6,5 X 10

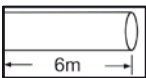

Ref: 2032003
P.V.P 18 €

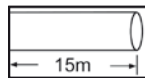

Ref: 2032005
P.V.P 30 €

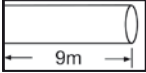

Ref: 2032004
P.V.P 27 €



AS-24A P.V.P: 7€
REGULADOR CAUDAL 1/4"

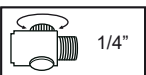

Ref: 2032237

AS-24C P.V.P: 12€
REGULADOR CAUDAL 1/4"

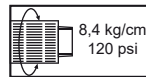
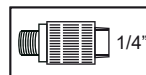

Ref: 2032261

Filtros / Reguladores / Lubricadores

AR-9007C P.V.P: 105€
FILTRO+REGULADOR+LUBRICADOR 1/2"

- 0.02 mm
- 0.5~8.5 kg/cm²
- 125ml
- 80ml
- 5 ~ 60°C



2200l/min

Ref: 2032780

AR-9008 P.V.P: 91€
FILTRO REGULADOR+LUBRICADOR

- 0.02 mm
- 0.5~8.5 kg/cm²
- 125ml
- 80ml
- 5 ~ 60°C



1750l/min

AR-9008A 1/4"
Ref: 2032680

AR-9008C 1/2"
Ref: 2032784

AR-9008MB P.V.P: 54€
MINI FILTRO REGULADOR+LUBRICADOR 1/4"

- 0.02 mm
- 0.5~8.5 kg/cm²
- 5 ~ 60°C



Ref: 2032783

AR-9008FR P.V.P: 68€
FILTRO REGULADOR

- 0.02 mm
- 0.5~8.5 kg/cm²
- 80ml
- 5 ~ 60°C



AR-9008FRA 1/4"
Ref: 2032681

AR-9008FRC 1/2"
Ref: 2032682

AR-9007L P.V.P: 37€
LUBRICADOR

- 0.5~8.5 kg/cm²
- 125ml
- 5 ~ 60°C



AR-9007LA 1/4"
Ref: 2032580

AR-9007LC 1/2"
Ref: 2032581

AR-9007F P.V.P: 38€
FILTRO

- 0.02 mm
- 0.5~8.5 kg/cm²
- 80ml
- 5 ~ 60°C



AR-9007FA 1/4"
Ref: 2032785

AR-9007FC 1/2"
Ref: 2032781

AR-9009RA P.V.P: 30€
REGULADOR AIRE 1/4"

- 0.5~8.5 kg/cm²
- 5 ~ 60°C



Ref: 2032522

AR-9007R P.V.P: 43€
REGULADOR



AR-9007RA 1/4"
Ref: 2032520

AR-9007RC 1/2"
Ref: 2032521

AR-9007E P.V.P: 245€
FILTRO+REGULADOR+LUBRICADOR 1"

- 0.005 mm
- 16,32 kg/cm²
- 350ml
- 350ml
- 5 ~ 60°C
- 1"
- 5200l/min

Ref: 2032779

AR-9007FE+RE P.V.P: 205€
FILTRO+REGULADOR 1"

- 0.005 mm
- 16,32 kg/cm²
- 350ml
- 5 ~ 60°C
- 1"
- 5200l/min

Ref: 2032775 + 2032778

AR-9007FRE P.V.P: 205€
FILTRO REGULADOR 1"

- 0.005 mm
- 16,32 kg/cm²
- 350ml
- 5 ~ 60°C
- 1"
- 5200l/min

Ref: 2032777

AR-9007FE P.V.P: 110€
FILTRO 1"

- 0.005 mm
- 16,32 kg/cm²
- 350ml
- 5 ~ 60°C
- 1"

Ref: 2032778

AR-9007LE P.V.P: 99€
LUBRICADOR 1"

- 16,32 kg/cm²
- 350ml
- 5 ~ 60°C
- 1"

Ref: 2032776

AR-9007RE P.V.P: 96€
REGULADOR 1"

- 16,32 kg/cm²
- 5 ~ 60°C
- 1"

Ref: 2032775

AS-23A P.V.P: 13€
SEPARADOR DE AGUA 1/4"

Ref: 2032245

AS-25A P.V.P: 14€
ARTICULACIÓN AIRE 1/4"

Ref: 2032247

AS-49C (75mm) P.V.P: 1,60€/u
DISCO DE CORTE 1 mm. Ref: 2032151C

AS-49B (75mm) P.V.P: 1,60€/u
DISCO DE CORTE 2 mm. Ref: 2032151A

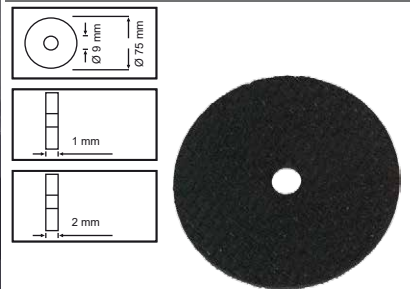

*paquete 25 unidades

AS-49B1 (100mm) P.V.P: 1,80€/u
DISCO DE CORTE 1 mm. Ref: 2032149A

AS-49B2 (100mm) P.V.P: 1,80€/u
DISCO DE CORTE 2 mm. Ref: 2032149B

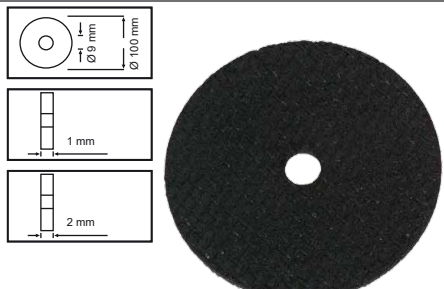

*paquete 25 unidades

AX-111 P.V.P: 1,10€/u
DISCO DE CORTE
115x1x22mm. (25 unidades) Ref: 2032419

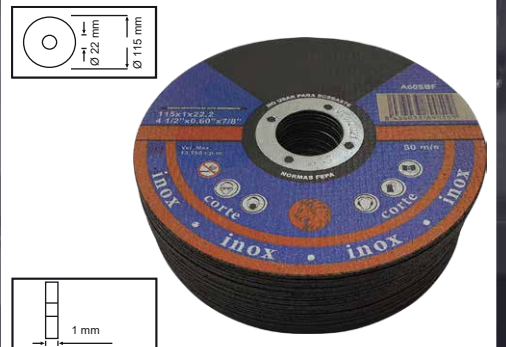

2032111-A P.V.P: 16€
JUEGO DE PLATOS PARA AR-3502 (78 - 115 - 140mm)



AS-3501BM-6 P.V.P: 22€
Ø 30mm

AS-3501AM-45 P.V.P: 25€
Ø 50mm - tornillo de 8mm

AS-3501AM-75 P.V.P: 28€
Ø 75mm - tornillo de 8mm

AS-825-K40 P.V.P: 21€
Ø 75mm - tornillo de 6mm



AS-13 P.V.P: 17€
PLATO DE LIJADORA ADHESIVO Ref: 2032685

AS-15 P.V.P: 18€
PLATO DE LIJADORA VELCRO Ref: 2032687



AS-14 P.V.P: 17€
PLATO DE LIJADORA ADHESIVO Ref: 2032686

AS-16 P.V.P: 20€
PLATO DE LIJADORA VELCRO Ref: 2032688

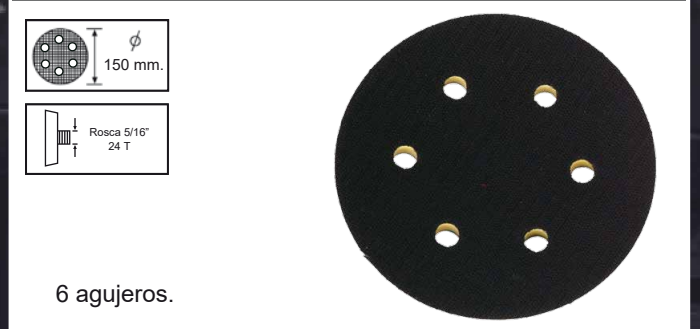

AS-11H P.V.P: 32€
PLATO F. 15 AGUJEROS

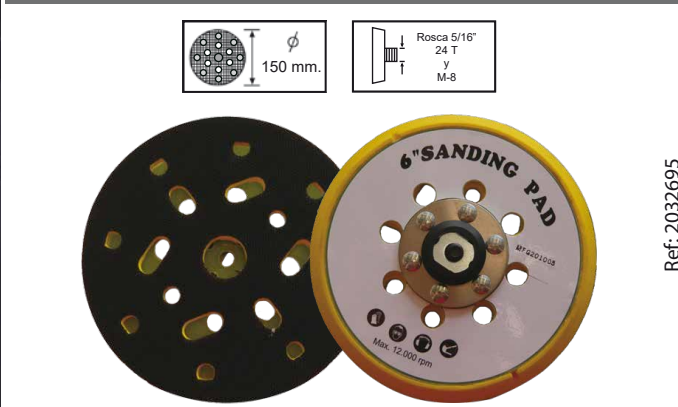

AS-07H P.V.P: 42€
PLATO DE LIJADORA AUT. ASPIRACIÓN 15 AGUJEROS

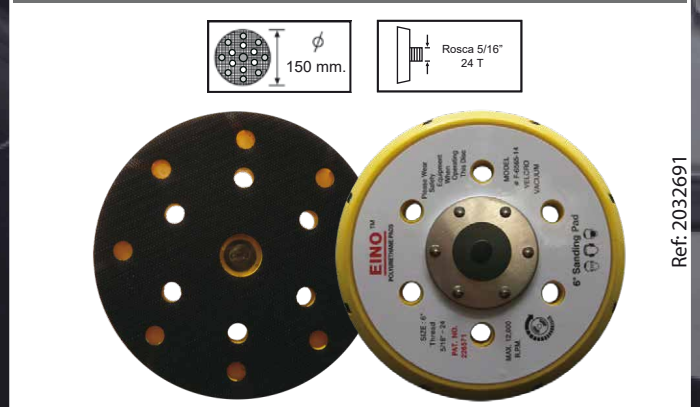

AS-52A	P.V.P: 13€ / 10u
LIJA DE CINTA GRANO 100 (PARA AR-7001)	
	
Ref: 2032116A	
	

AS-52D	P.V.P: 16€ / 10u
LIJA DE CINTA PARA AR-7001 Ref: 2032116D PARA PUNTOS DE SOLDADURA GRANO 40	
	
Ref: 2032116B	
	

AS-52C	P.V.P: 18€ / 10u
LIJA DE CINTA GRANO 100 (PARA AR-7003)	
	
Ref: 2032117B	
	

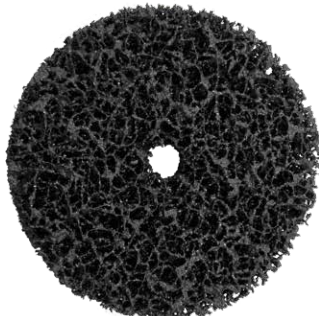
STW002	P.V.P: 11€
DISCO FIBRA NYLON Ø100	
	

STW004	P.V.P: 17€
DISCO FIBRA NYLON Ø150	

SDC601	P.V.P: 8€
DISCO FIBRA NYLON	
Ref: SDC601 Diámetro 45mm Conexión rápida Para usar con AS-103 Compatible con 3M	
	
Ref: SDC601	

AS-105	P.V.P: 23€
KIT ÚTILES LIJADO Ref: 2032128	
	
*conexión rápida compatible con 3M	

AS-103	P.V.P: 17€
DISCO FIBRA NYLON Ref: 2032130	
	
*conexión rápida compatible con 3M	

DISCO MIL HOJAS	P.V.P: 7,50€
GRANO 80. PARA USAR CON AS-103 Ref: 230690	
DISCO MIL HOJAS	P.V.P: 7,50€
GRANO 40. PARA USAR CON AS-103 Ref: 230691	
Diámetro 50mm Conexión rápida Compatible con 3M	
	

DLCZ05	P.V.P: 3,90€/u
DISCO ZK80 CÓNICO GRANO 80 (CAJA DE 10 unid.)	
DIÁMETRO 115x22mm.	
	
Ref: DLCZ05	

ENCHUFE DE SEGURIDAD

Mecanismo de seguridad que **evita latigazos** accidentales de la manguera

Mínimo esfuerzo para la conexión, apriete óptimo

Norma: ISO 4414

Enchufes fabricados **sin silicona**, impidiendo a los usuarios numerosos problemas en aplicación pintura.

Gracias a la composición de los materiales, **son ligeros**. Eso permite al usuario hacer un trabajo preciso y sin cansancio.

El material compuesto, en comparación con el metal, **nunca está frío**. El compuesto no deja traza odorante en las manos, está flexible y su textura antideslizante.

El cuerpo compuesto con una base de fibras de vidrio **impide todo riesgo de ralladura** de los materiales frágiles (carrocerías de coche, pantallas, muebles...)

Cuerpos de enchufe fabricados con fibra de vidrio alta resistencia que ofrece una **solidez extrema** Alta resistencia a la abrasión, absorción de golpes, resistente al aplastamiento, resistente a las vibraciones.

Realizados con acero tratado con una **protección anti-corrosiva**. Las roscas machos son cónicas y preteflonadas para un montaje fácil, rápido y estanco.

Presión nominal:

Serie 24: 0 a 16 bar (883 l/min)

Serie 26: 2 a 12 bar (1470 l/min)

Temperatura de uso: de -15°C a +70°C



ENCHUFE ROSCA MACHO

SERIE 24

AB-061151	1/4"	P.V.P 24,00 €
AB-061152	3/8"	P.V.P 24,00 €
AB-061153	1/2"	P.V.P 24,00 €



ENCHUFE ROSCA MACHO

SERIE 26

AB-071151	1/4"	P.V.P 24,00 €
AB-071152	3/8"	P.V.P 24,00 €



ENCHUFE ROSCA HEMBRA

SERIE 24

AB-061101	1/4"	P.V.P 21,00 €
AB-061102	3/8"	P.V.P 24,00 €



ENCHUFE ROSCA HEMBRA

SERIE 26

AB-071101	1/4"	P.V.P 21,00 €
AB-071102	3/8"	P.V.P 24,00 €



ENCHUFE ESPIGA

SERIE 24

AB-061808	8mm	P.V.P 24,00 €
AB-061810	10mm	P.V.P 24,00 €



ENCHUFE ESPIGA

SERIE 26

AB-071808	8mm	P.V.P 24,00 €
AB-071810	10mm	P.V.P 24,00 €



También disponibles en tramos a medida con manguera super flexible

*consultar precio según longitud/diámetro manguera y tipos de conexión

MOD. 500 ZMK

ENCHUFE METÁLICO UNIVERSAL MACHO

63550014	1/4"	P.V.P 6,60 €
63550038	3/8"	P.V.P 6,90 €
63550012	1/2"	P.V.P 9,40 €

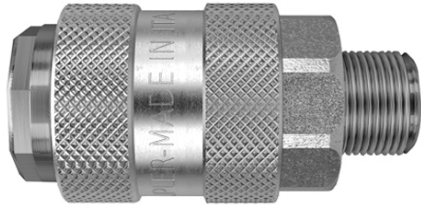

MOD. 500 ZMK

ENCHUFE METÁLICO UNIVERSAL HEMBRA

63550114	1/4"	P.V.P 7,40 €
63550138	3/8"	P.V.P 7,90 €
63550112	1/2"	P.V.P 9,90 €

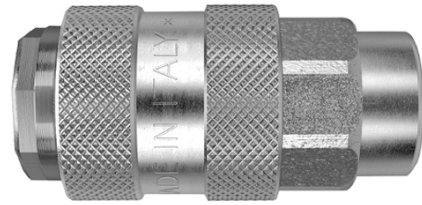

MOD. 500 ZMK

ENCHUFE METÁLICO UNIVERSAL ESPIGA

635504008	8mm	P.V.P 6,80 €
635504010	10mm	P.V.P 6,80 €
635504012	12mm	P.V.P 8,50 €



MOD. 514/A Y 514/T

RACORD MACHO

641402	1/4" serie 24	P.V.P 1,60 €
641403	3/8" serie 24	P.V.P 2,90 €
611402	1/4" serie 26	P.V.P 1,60 €
611403	3/8" serie 26	P.V.P 2,10 €



MOD. 515/A Y 515/T

RACORD HEMBRA

641502	1/4" serie 24	P.V.P 2,00 €
641503	3/8" serie 24	P.V.P 2,90 €
611502	1/4" serie 26	P.V.P 2,00 €
611503	3/8" serie 26	P.V.P 2,90 €



MOD. 524/A Y 524/T

RACORD ESPIGA

642406	6 mm. serie 24	P.V.P 2,40 €
642408	8 mm. serie 24	P.V.P 2,40 €
642410	10 mm. serie 24	P.V.P 2,70 €
612406	6 mm. serie 26	P.V.P 2,40 €
612408	8 mm. serie 26	P.V.P 2,40 €
612410	10 mm. serie 26	P.V.P 2,50 €



RACORD ARTICULADO 1/4"

2032280	serie 24 macho	Descatalogado
2032321	serie 26 macho	P.V.P: 6,20€
2032322	serie 26 hembra	P.V.P: 6,20€
2032280A	articulación hembra-macho 1/4"	P.V.P: 5,80€

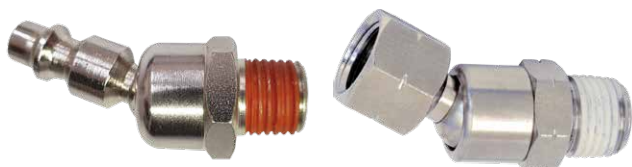

SERIES

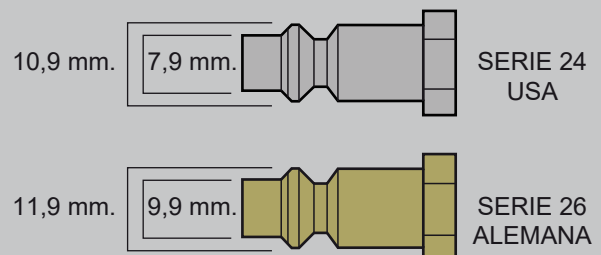

MOD. 018

CONEXIÓN ESPIGA MACHO

601811	1/4" 6 mm.	P.V.P 1,80 €
601814	1/4" 8 mm.	P.V.P 1,80 €
601815	1/4" 10 mm.	P.V.P 2,00 €
601825	3/8" 10 mm.	P.V.P 2,20 €
601826	3/8" 12 mm.	P.V.P 2,40 €



MOD. 018F

CONEXIÓN ESPIGA HEMBRA

601873	1/4" 8 mm.	P.V.P 1,90 €
601875	1/4" 10 mm.	P.V.P 1,90 €



MOD. 524/D

CONEXIÓN DOBLE ESPIGA

603406	6 mm.	P.V.P 2,60 €
603408	8 mm.	P.V.P 3,60 €
603410	10 mm.	P.V.P 3,70 €



MOD. N

UNIÓN DOBLE MACHO

607001	1/8" - 1/8"	P.V.P 1,40€
607004	1/4" - 1/4"	P.V.P 1,80€
607005	1/4" - 3/8"	P.V.P 2,00€
607006	1/4" - 1/2"	P.V.P 2,90€
607007	3/8" - 3/8"	P.V.P 2,50€
607008	3/8" - 1/2"	P.V.P 3,00€
607009	1/2" - 1/2"	P.V.P 3,10€



MOD. RP

REDUCCIÓN HEMBRA / MACHO

607205	H1/2" - M1/4"	P.V.P 3,20 €
607207	H1/2" - M3/8"	P.V.P 3,40 €



MOD. R

REDUCCIÓN MACHO / HEMBRA

607101	M1/4" - H1/8"	P.V.P 1,40 €
607102	M3/8" - H1/4"	P.V.P 2,00 €
607103	M1/2" - H1/4"	P.V.P 3,10 €
607104	M1/2" - H3/8"	P.V.P 3,30 €
607107	M3/4" - H1/2"	P.V.P 4,50 €
607105	M1" - H3/4"	P.V.P 6,80 €
607106	M1" - H1/2"	P.V.P 7,50 €



MOD. M

UNIÓN DOBLE HEMBRA

607303	H1/4" - H1/4"	P.V.P 1,50€
607306	H3/8" - H3/8"	P.V.P 2,40€



MOD. TP

TAPÓN CILÍNDRICO

607401	M1/8"	P.V.P 1,20€
607402	M1/4"	P.V.P 1,30€
607403	M3/8"	P.V.P 1,80€
607404	M1/2"	P.V.P 2,50€



MOD. 32

"Y" (macho - hembra hembra)

AS030101	1/4"	P.V.P 3,80€
AS030105	1/2"	P.V.P 8,90€



MOD. 630

"Y" (hembra - hembra hembra)

AS030501	1/4"	P.V.P 3,80 €
AS030503	1/2"	P.V.P 8,30 €



TT20814NI

"T" TRIPLE MACHO 1/4"

P.V.P: 3,20€



2032438

P.V.P: 142€

GENERADOR DE OZONO 20.000 mg/h

- Voltaje: 110V/220V
- Salida de ozono: 20000 mg/h
- Tamaño del producto: 200x180x160mm
- Peso del producto: 2kg

Efectivo para:

- Formaldehído
- PM2.5
- Bacterias
- Humo de tabaco
- Virus
- Benceno
- Mal olor
- Polen
- TVOC



Ref: 2032438

C330/03

P.V.P: 1.271€*

COMPACT-AIR 330 - COMPRESOR BICILÍNDRICO EN SECO

IDEAL PARA ARTESANOS, PEQUEÑAS Y MEDIANAS EMPRESAS.

SERIE C330:

- Sin tanque, manejable y compacto.
- 330 litros / minuto (11,6 CFM)
- 80 decibelios
- 39 Kg.

EL SISTEMA DE DOBLE PISTÓN:

- El sistema patentado de doble pistón reduce drásticamente el desgaste evitando así el mantenimiento frecuente que requieren los compresores comunes.

CALIDAD PROFESIONAL

- La serie C330 se produce, monta y prueba en Italia. Cada máquina se somete a estrictos controles antes de lanzarse al mercado.
- Su reducido número de revoluciones del motor (1.400 rpm) garantiza su utilización las 24h del día sin problemas de sobrecalentamiento.

SECTORES DE UTILIZACIÓN:

- Concebido para uso profesional
- La ausencia de aceite lubricante hace que el C330 sea ideal para el transporte, debido a que se puede poner en cualquier posición y además puede ser usado en ambientes con polvo y bajas temperaturas.

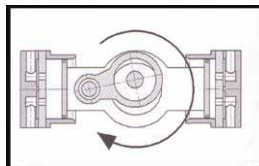

COMPARABLE A UN COMPRESOR NORMAL DE 100 LITROS Y 3 CV. CON CORREAS, PERO CON UNAS DIMENSIONES Y PESO EXTREMADAMENTE BAJOS



Ref: 200828002

TRATAMIENTO ANTI-FRICCIÓN 73000250 (250ml)

Aumenta la compresión y el rendimiento del motor.
Mejora y aumenta la lubricación.
Optimiza y mejora la calidad de la lubricación.
Prolonga la vida de los motores, rodamientos y maquinaria.
Reduce la temperatura de trabajo del motor.
Disminuye el consumo de aceite.
Reduce la fricción en los motores hasta un 70%.
Minimiza los ruidos internos en motores y engranajes.
Aplicable a todo tipo de motores, diesel, gasolina, gas, etc.
Apto para transmisiones manuales.
Compatible con lubricantes sintéticos y minerales.
No modifica la viscosidad original de los lubricantes.
Garantizado para 100.000 km en automóviles o 2.000 horas de trabajo.

*otras medidas consultar



TRATAMIENTO ANTI-FRICCIÓN PARA TRANSMISIONES AUTOMÁTICAS 74000250 (250ml)

Reducción significativa del desgaste suavizando el cambio de marchas y prolongando la vida de todo el sistema de transmisión.
Protege el sistema contra la oxidación y la corrosión.
Mejora y suaviza el funcionamiento general.
Previene gripajes y sobrecalentamientos del sistema, evitando dañinas averías y costosas reparaciones.
Evita fugas manteniendo una condición perfecta de sellado. No contiene ningún tipo de partículas solidas en su composición, como por ejemplo: Teflón, Molibdeno, grafito, cerámica, silicio, etc. Tampoco contiene ácidos, cloro o ningún otro tipo de derivado del cloro ni agente corrosivo.
Tratamiento idóneo para sistemas de cambio automáticos, variadores de velocidad, engranajes y en equipos donde componentes como discos y elementos electrónicos requieren estar bañados en aceite.

*otras medidas consultar



INJECT CLEANER 69000400 (400ml)

SUPERLIMPIADOR DE INYECTORES Y CÁMARA DE COMBUSTIÓN
Limpieza eficaz del sistema de inyección. Compensa el uso regular del gasóleo con un bajo contenido en azufre.
Corrige la mala pulverización (Obstrucción de difusores).
Corrige la emisión de CO (monóxido de carbono) y HC (hidróxido de carbono) no quemados, reduciendo todas las emisiones nocivas.
Asegura un preciso asiento de válvulas (Limpieza de varilla y asientos de válvula).
Mejora la relación de compresión.
Mejora sustancialmente el arranque en frío.
Reduce las emisiones de humo.
Emulsiona el agua que se genera en los depósitos de combustible.
Incrementa el octanaje del combustible, mejorando la combustión y la respuesta del motor.
Previene el óxido y la corrosión en depósitos y sistemas de combustible.

*otras medidas consultar



MOTOR FLUSH 67000250 (250ml)

LIMPIADOR CONCENTRADO
Mantiene el interior del motor limpio.
Disuelve la carbonilla, eliminando incrustaciones y depósitos dañinos para el motor.
Preserva la calidad original del aceite, alargando su durabilidad.
Prolonga la vida útil del motor.
Permite una lubricación interna óptima.
Reduce la polución de forma activa (minimiza las emisiones de hidrocarburos).
Disuelve los depósitos de lodos y partículas manteniéndolas suspendidas en el aceite usado y permitiendo eliminarlos en el momento del vaciado.
El Limpiador concentrado Motor Flush es ideal para la limpieza segura de los canales de aceite de motores en coches y furgonetas, autocares y autobuses, camiones, maquinaria agrícola e industrial, etc.

*otras medidas consultar



AEROSOL MULTI-PROPÓSITO 21000400 (400ml)

Reduce el desgaste enérgicamente.
Desplaza la humedad.
Elimina y protege de la humedad, permitiendo el arranque de motores mojados (poderoso efecto dieléctrico).
Afloja y desatasca tuercas, tornillos o mecanismos bloqueados y agarrotados por el óxido.
Elimina los molestos ruidos y chirridos.
Penetra y limpia desplazando la suciedad.
Lubrica y protege contra la corrosión y la humedad.
Limpia y disuelve grasas eficazmente.
Apto para lubricar cadenas, ejes de vagonetas y rodamientos agarrotados.
Eficiente rendimiento como aceite de corte y mecanizado, alargando la vida útil de las herramientas.

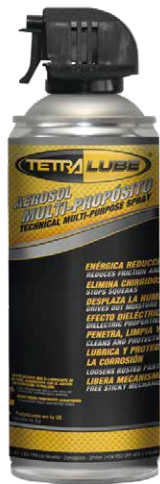

TRATAMIENTO PRE-ITV 63000400 (400ml. DIÉSEL) 64000400 (400ml. GASOLINA)

Reduce en más de un 40% las emisiones nocivas de escape.
Mejora exponencialmente la combustión y la respuesta del motor.
Minimiza todas las emisiones nocivas del motor.
Reduce el consumo de combustible.
Mejora sustancialmente el arranque en frío.
Emulsiona el agua que se genera en los depósitos de combustible.
Previene el óxido y la corrosión en depósitos y sistemas de combustible.
El Tratamiento Eliminador de Humos Pre-ITV posee un efecto tremendamente poderoso, apenas 400 ml son suficientes para tratar hasta 80 litros de combustible de modo eficiente.

*otras medidas consultar



STOP-LEAK OIL 68000250 (250ml)

TRATAMIENTO ANTIFUGAS ACEITE

Está especialmente diseñado para restaurar y mantener la flexibilidad de las juntas de goma sintética y/o natural, ayudando a reducir y eliminar fugas de aceite y a evitar su repetición en el futuro. Devuelve a los sellos, juntas y retenes su textura y gomosidad original.

Libera los atascos en los anillos de pistones. Reduce drásticamente los depósitos de las válvulas.

Silencia los elevadores de las válvulas. Disuelve y suspende la existencia y formación de depósitos.

Aumenta el rendimiento y la estabilidad de los componentes blandos tratados hasta un 70% STOP-LEAK OIL permite a los anillos y válvulas mejorar y optimizar su función de sellado, reduciendo también el consumo de aceite.

*otras medidas consultar



STOP LEAK RADIATOR 65000400 (400ml)

PROTEGE, REPARA Y SELLA EL CIRCUITO DE REFRIGERACIÓN

*otras medidas consultar

Detiene las fugas en el sistema de refrigeración de forma rápida y eficaz.

Previene y tapa fugas en todo el circuito de agua, bomba, mangueras, termostatos, intercambiadores de calefacción, etc.

Evita la formación de incrustaciones de óxido y cal. Suprime fugas y filtraciones en el bloque y cilindros de costosa reparación.

Lubrica y protege válvulas, termostatos y bombas de agua.

Compatible con todos los anticongelantes de base monoetilenglicol, incluidos los orgánicos (OAT)

Asegura una máxima protección sin bloquear el circuito de refrigeración en los motores de última generación.

Mejora el rendimiento de la refrigeración y la calefacción del motor.



CLEAN RADIATOR 95001000 (1.000ml)

LIMPIADOR DE RADIADORES

Emulsiona y elimina rápidamente lodos, aceites, grasa y óxidos que se originan en los radiadores y los sistemas de refrigeración.

Neutraliza eficientemente las incrustaciones originadas dentro del sistema, óxidos, carbonatos, etc.

Combate y previene eficazmente la oxidación de los metales y la formación de depósitos de óxido. Previene los sobre-calentamientos del radiador y del motor, protegiéndolos de posibles daños derivados.

La formula de Clean Radiator es compatible con las aleaciones normalmente usadas en los radiadores (incluidas las de aluminio), plásticos, gomas y otros materiales para juntas.

Su empleo regular mantiene eficacia del sistema de refrigeración realizando una función preventiva. Ahorra tiempo y dinero gracias a su rápida limpieza de sólo 15 minutos sin necesidad de herramientas ni equipamientos adicionales; ahorrando costosas paradas en el taller.

*otras medidas consultar



TRATAMIENTO ANTI-ALGAS 70000250 (250ml)

PARA TANQUES Y DEPÓSITOS DE COMBUSTIBLE

*otras medidas consultar

Altísima eficacia frente a hongos, levaduras y bacterias desintegrándolas y emulsionándolas, eliminando así la principal causa de obstrucciones y tapones en todos los filtros de combustible.

Reduce costes de mantenimiento de instalaciones, flotas de vehículos y sistemas de calefacción.

Evita los desagradables olores producidos por la acumulación de algas.

Larga protección interna en todos los depósitos de combustible. Estable en un amplio rango de temperaturas (hasta 60°C).

No es corrosivo.

En un máximo de 36 horas el depósito estará tratado y desinfectado.

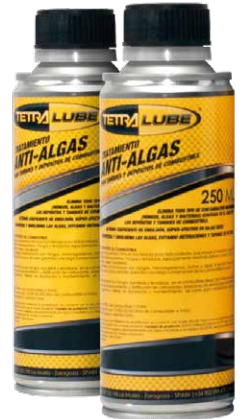

GRASA UNIVERSAL 94000400 (400ml)

DE ALTAS PRESTACIONES

Gran adhesividad y elevada adherencia, garantiza el máximo poder lubricante.

Propiedades antioxidantes, anticorrosivas y antidesgaste, todo en la misma grasa.

Excelente rendimiento con elevadas temperaturas y altas revoluciones.

Óptimo comportamiento ante fuertes cargas y vibraciones.

Aplicable no sólo en una gran variedad de mecanismos, sino también en muy diversas condiciones de funcionamiento,

sobre maquinaria sometida a temperaturas comprendidas entre -30 y +180°C

entre -30 y +180°C e incluso en presencia de humedad, alargando los intervalos de mantenimiento.

Prolonga la vida de los motores, rodamientos y maquinaria.

Extraordinaria resistencia al agua (dulce y/o salada) y otros líquidos.

*otras medidas consultar



GRASA LÍQUIDA ADHESIVA 24000400 (400ml)

CON TRATAMIENTO ANTI-FRICCIÓN

Se adhiere rápidamente y de forma duradera a las superficies a lubricar, desplaza la humedad y ofrece una excelente protección anticorrosión y antidesgaste..

Su rápida adhesión la hace especialmente indicada para lubricar en áreas difíciles, resistiendo durante más tiempo y ofreciendo una protección duradera de las piezas tratadas.

Muy filante y sin goteo. Su alto poder de penetración le permite llegar a los sitios más difíciles de fricción y desgaste.

Resiste a las altas presiones, al agua, agua salada, ácidos, bases e hidrocarburos.

Resistencia a temperaturas desde -35 °C hasta 200 °C.

Protege sin manchar, repele el polvo y la humedad de forma estable y duradera.



KERAMIC PASTE AEROSOL 22000400 (400ml)

PASTA CERÁMICA ANTI-GRIPANTE

Gracias a su alto contenido en lubricante cerámico sólido, hace posible la separación de elementos, después de largo periodo sometidos a altas temperaturas y condiciones adversas. Reduce activamente la fricción, el desgaste y la corrosión, incluso cuando se haya evaporado el aceite de base. Resistente a altas temperaturas y a altas presiones (-20° C a 1.200°C). Protege contra las incrustaciones, la corrosión, el oxidamiento, el agarrotamiento y las presiones extremas. Montaje fácil y rápido de piezas roscadas, idóneo como pasta de montaje. Previene la corrosión por acidez, sal o sosas. No se elimina con agua, resistente al agua fría y caliente. No contiene metales libres, ni plomo, cobre, níquel, azufre ni tampoco mezclas de los mismos.



ALL CLEAN LIMPIADOR 23000500 (500ml)

DESENGRASANTE INDUSTRIAL

Disuelve rápidamente grasas, aceites, lubricantes, adhesivos y alquitrán. Acaba de manera eficiente con diferentes agentes contaminantes. Producto de rápida evaporación que reduce los tiempos de trabajo. Asegura un acabado rápido y eficiente. Es estable, no mancha ni produce corrosión en metales. No deja residuos tras su aplicación, no requiere enjuague posterior. Seguro con la mayoría de plásticos, gomas y revestimientos. No contiene cloro, derivados ni disolventes clorados. Aerosol provisto de Válvula 360°, rocía el producto incluso en posición invertida.



TRATAMIENTO ANTICONGELANTE 62001000 (1.000ml)

FLUIDIFICANTE PARA DIÉSEL

Efecto antigongelante y fluidificante, mejora rápidamente la fluidez del carburante diésel y facilita el paso por el filtro del combustible. Evita el congelamiento del gasoil a temperaturas bajas. Limpia y mantiene limpio todo el sistema de inyección. Inhibe la corrosión de depósitos, tanques, tubing y sistema de inyección. Mejora la combustión del carburante. No altera las propiedades del gasoil. Neutraliza alto contenido de azufre de combustible. Evita la formación de gomas provenientes de compuestos insolubles contenidos en el diésel. Actúa incluso con temperaturas exteriores de hasta -31°C, siempre en función de la calidad del combustible diésel tratado.

*otras medidas consultar



AEROSOL TURBO CLEANER 66000500 (500ml)

LIMPIADOR PARA TURBOS Y SISTEMAS DE ADMISIÓN

Elimina y previene la formación de depósitos en toda la instalación de aspiración (oleaginosos y carbonosos). Óptimo para una limpieza energética y rápida de las válvulas de admisión y toda la cámara de combustión. Aumenta el rendimiento del motor y disminuye el consumo de combustible. No daña la capa protectora de la superficie interna de la admisión. Limpia todos los restos carbonosos muy dañinos para los silenciadores con catalizador. Ayuda a restablecer la circulación del aire y mejora la mezcla combustible/aire. Reduce la carga del filtro de partículas, alargando la vida del mismo y en general del motor. Especialmente indicado para limpiar componentes como válvula EGR, válvula de regulación de ralentí, carburador, caja de mariposas (Electronic Throttle Module), sensor de presión del colector de admisión, sistema de ventilación del cárter... Perfecto para limpiar piezas desmontadas.



AEROSOL LIMPIADOR DPF 98000500 (500ml)

PARA FILTROS DE PARTÍCULAS DPF

Repara, regenera, limpia y mantiene el filtro de partículas. Disuelve las partículas de hollín y ceniza en el filtro. Ayuda a la regeneración y limpieza de filtros de partículas diésel. Optimiza el rendimiento del motor y disminuye las emisiones nocivas. Fácil y económico, no requiere el uso especial de herramientas ni tampoco el desmontaje del sistema de escape o del filtro de partículas. Reduce hasta un 25% la temperatura requerida para el inicio del ciclo de post combustión del hollín acumulado dentro del filtro. Producto no agresivo. Especialmente indicado para vehículos diésel con sistemas cerrados de filtros de partículas diésel. Compatible con todos los vehículos con motor diésel equipados con DPF/FAP.



PROTECTOR REGENERADOR DPF 71001000 (1.000ml)

PARA FILTROS DE PARTÍCULAS DPF

Asegura la completa y rápida regeneración del filtro de partículas. Alarga la vida útil del filtro de partículas diésel. Reduce la formación de hollín y previene la obturación de los Filtros de Partículas Diésel (DPF). Acelera la combustión de las partículas de hollín, reduciendo además la temperatura de ignición de combustible. Reduce la emisión de partículas nocivas. Garantiza una perfecta combustión a temperaturas reducidas durante el funcionamiento normal del motor, reduciendo activamente el consumo de carburante. Previene costosas averías del filtro de partículas y largas estancias en el taller. Su empleo regular permite mantener limpio el filtro, mejorando la combustión y el rendimiento del motor. Puede ser utilizado en todos los motores diésel con filtro de partículas, incluso en los más modernos compatibles con normas Euro V y Euro VI.

*otras medidas consultar



LIMPIADOR DE FILTROS DE PARTÍCULAS DPF (PRODUCTO A) 96001000 (1.000ml)

Elimina eficazmente la saturación de los depósitos de carbón y hollín que impiden la regeneración del filtro. Ayuda a la regeneración y limpieza de filtros de partículas diésel. Garantiza un consumo menor y más eficiente de combustible a la par que reduce las emisiones nocivas. Optimiza la potencia del motor y restablece la presión en el escape. Es un producto totalmente seguro, no daña el filtro de partículas ni reacciona con otros componentes. Reduce drásticamente los gastos de servicio y mantenimiento de los vehículos permitiendo una limpieza profesional sin desmontaje.

Son necesarios el producto A y B. Uso exclusivo para profesional en taller.

*otras medidas consultar

ENJUAGUE LIMPIADOR DE FILTROS DE PARTÍCULAS DPF (PRODUCTO B) 97001000 (1.000ml)

Limpiador líquido de alta eficacia desarrollado para enjuagar filtros de partículas diésel (DPF/FAP) tras el lavado con el Limpiador de filtro de partículas diésel DPF (PRODUCTO A). Aclara y evacua los residuos persistentes, ayudando a la regeneración y limpieza de filtros de partículas diésel. Solución perfecta para limpiar rápida y eficazmente los filtros de partículas, evaporándose sin dejar residuo. Formulación neutra: No contiene cenizas, disolventes, metales ni catalizadores de combustión. Es un producto totalmente seguro, no daña el filtro de partículas ni reacciona con otros componentes. Reduce enormemente los gastos de servicio y mantenimiento de los vehículos permitiendo una limpieza profesional sin desmontaje.

*otras medidas consultar

TRATAMIENTO PREMIUM PARA DIÉSEL 10001000 (1000ml)

Disminuye el consumo de combustible, permitiendo un ahorro de hasta un 3%. Mejora la combustión, aumentando el índice de cetano, la capacidad de aceleración y el rendimiento. Estabiliza la calidad del combustible durante largos periodos de tiempo, protegiéndolo contra el agua y lodos. El combustible mejorado con el Tratamiento Premium facilita un mejor arranque en frío. Reduce drásticamente la emisión de humos blancos, de escape y hollín. Previene la aparición de fenómenos de corrosión en depósitos y sistemas de combustible. Reduce la formación de espuma, permitiendo repostajes más rápidos y sin salpicaduras. Reduce la sonoridad, vibraciones y el golpeteo del motor diésel. Disminuye la formación de carbonilla (humos negros) y el consumo de aceite. Efecto lubricante, compensa la falta de lubricación en carburantes pobres de azufre.

*otras medidas consultar

BOTELLA DE ACEITE PREMIUM PARA HERRAMIENTAS PNEUMÁTICAS P.V.P: 12,50€

1 LITRO

AR PNEUMATIC OIL

SAE 10 W
pneumatic edition

PREMIUM

ACEITE MONOGRADO ESPECIALMENTE DISEÑADO PARA LUBRIFICADORES O MANTENIMIENTO MANUAL EN HERRAMIENTAS PNEUMÁTICAS

Fabricado con bases parafínicas y aditivos de alta tecnología. Excelentes propiedades lubricantes y antidesgaste para prolongar la vida útil de las herramientas neumáticas. Gran resistencia a la oxidación y al envejecimiento. Elevado poder detergente y dispersante. Gran protección contra la corrosión.

CARACTERÍSTICAS		
DENSIDAD @ 20 °C	ASTM D-1289 / ISO 3075	0,87
VISCOSIDAD @ 100 °C, cSt	ASTM D-445 / ISO 3104	5,5
ÍNDICE DE VISCOSIDAD	ASTM D-2270 / ISO 2909	> 100
PUNTO DE INFLAMACIÓN, °C	ASTM D-92 / ISO 2592	200
PUNTO DE CONGELACIÓN, °C	ASTM D-37 / ISO 3016	-33
TBN	ASTM D-2896 / ISO 3371	6,1

ESPECIFICACIONES
- API: CF/SG
- ACEA: E2
- CONSTRUCTORES: MB 228.0 / ALLISON C-4

1L.

Ref: 2032323

EMPAQUETADO TETRALUBE

250ml. 12 unidades/caja
400ml. 12 unidades/caja
1000ml. 6 unidades/caja

TARIFA TETRALUBE

DESCRIPCIÓN	REFERENCIA	UD. / ENV.	UD. VENTA.	P.V.P.
TRATAMIENTO ANTIFRICCIÓN 250 ML.	73000250	12x250 ML.	BOTE DE 250 ML.	29,87 €
TRATAMIENTO ANTIFRICCIÓN 1 L.	73001000	6x1 L.	BOTE DE 1 L.	75,05 €
TRATAMIENTO ANTIFRICCIÓN 5 L.	73005000	4x5 L.	LITRO	65,07 €
TRATAMIENTO ANTIFRICCIÓN 25 L.	73025000	1x25 L.	LITRO	61,83 €
TRATAMIENTO ANTIFRICCIÓN 200 L.	73200000	1x200 L.	LITRO	55,40 €
TRAT. ANTIFRICCIÓN CAMBIO AUTOMÁTICO 250 ML.	74000250	12x250 ML.	BOTE DE 250 ML.	31,21 €
TRAT. ANTIFRICCIÓN CAMBIO AUTOMÁTICO 1 L.	74001000	6x1 L.	BOTE DE 1 L.	76,33 €
LIMPIADOR DE INYECTORES INJECT-CLEANER 400 ML.	69000400	12x400 ML.	BOTE DE 400 ML.	23,00 €
LIMPIADOR DE INYECTORES INJECT-CLEANER 1 L.	69001000	6x1 L.	BOTE DE 1 L.	43,94 €
LIMPIADOR DE INYECTORES INJECT-CLEANER 5 L.	69005000	4x5 L.	LITRO	41,75 €
LIMPIADOR DE INYECTORES INJECT-CLEANER 25 L.	69025000	1x25 L.	LITRO	39,93 €
LIMPIADOR DE INYECTORES INJECT-CLEANER 200 L.	69200000	1x200 L.	LITRO	34,90 €
LIMPIADOR CONCENTRADO MOTOR FLUSH 250 ML.	67000250	12x250 ML.	BOTE DE 250 ML.	33,70 €
LIMPIADOR CONCENTRADO MOTOR FLUSH 1 L.	67001000	6x1 L.	BOTE DE 1 L.	87,57 €
LIMPIADOR CONCENTRADO MOTOR FLUSH 5 L.	67005000	4x5 L.	LITRO	83,20 €
LIMPIADOR CONCENTRADO MOTOR FLUSH 25 L.	67025000	1x25 L.	LITRO	79,02 €
AEROSOL MULTIPROPÓSITO 400 ML.	21000400	12x400 ML.	AEROSOL 400 ML.	23,89 €
TRATAMIENTO PRE-ITV PARA DIESEL 400 ML.	63000400	12x400 ML.	BOTE DE 400 ML.	26,14 €
TRATAMIENTO PRE-ITV PARA DIESEL 1 L.	63001000	6x1 L.	BOTE DE 1 L.	52,00 €
TRATAMIENTO PRE-ITV PARA GASOLINA 400 ML.	64000400	12x400 ML.	BOTE DE 400 ML.	26,14 €
TRATAMIENTO PRE-ITV PARA GASOLINA 1 L.	64001000	6x1 L.	BOTE DE 1 L.	52,00 €
TRATAMIENTO TAPAFUGAS STOP-LEAK OIL 250 ML.	68000250	12x250 ML.	BOTE DE 250 ML.	25,57 €
TRATAMIENTO TAPAFUGAS STOP-LEAK OIL 1 L.	68001000	6x1 L.	BOTE DE 1 L.	66,00 €
TRATAMIENTO TAPAFUGAS STOP-LEAK OIL 5 L.	68005000	4x5 L.	LITRO	62,69 €
TRATAMIENTO TAPAFUGAS STOP-LEAK OIL 25 L.	68025000	1x25 L.	LITRO	59,56 €
TAPAFUGAS STOP LEAK RADIATOR 400 ML.	65000400	12x400 ML.	BOTE DE 400 ML.	18,72 €
TAPAFUGAS STOP LEAK RADIATOR 1 L.	65001000	6x1 L.	BOTE DE 1 L.	37,28 €
LIMPIADOR DESINCRUSTANTE CLEAN-RADIADOR 1 L.	95001000	6x1 L.	BOTE DE 1 L.	44,63 €
LIMPIADOR DESINCRUSTANTE CLEAN-RADIADOR 5 L.	95005000	4x5 L.	LITRO	36,36 €
LIMPIADOR DESINCRUSTANTE CLEAN-RADIADOR 25 L.	95025000	1x25 L.	LITRO	34,54 €
TRATAMIENTO BIOCIDA ANTI-ALGAS 250 ML.	70000250	12x250 ML.	BOTE DE 250 ML.	23,93 €
TRATAMIENTO BIOCIDA ANTI-ALGAS 1 L.	70001000	6x1 L.	BOTE DE 1 L.	68,38 €
TRATAMIENTO BIOCIDA ANTI-ALGAS 5 L.	70005000	4x5 L.	LITRO	64,98 €
TRATAMIENTO BIOCIDA ANTI-ALGAS 25 L.	70025000	1x25 L.	LITRO	61,72 €
TRATAMIENTO BIOCIDA ANTI-ALGAS 200 L.	70200000	1x200 L.	LITRO	58,00 €
GRASA DE ALTAS PRESTACIONES NLGI-II 400 GR.	94000400	12x400 GR.	CART. 400 GR.	25,14 €
GRASA DE ALTAS PRESTACIONES NLGI-II 5 KG.	94005000	4x5 KG.	KILO	40,64 €
GRASA DE ALTAS PRESTACIONES NLGI-00 18 KG.	94018000	1x18 KG.	KILO	35,86 €
GRASA DE ALTAS PRESTACIONES NLGI-II 20 KG.	94020000	1x20 KG.	KILO	39,14 €
GRASA DE ALTAS PRESTACIONES NLGI-II 45 KG.	94045000	1x45 KG.	KILO	37,05 €
GRASA LÍQUIDA ADHESIVA CON T. ANTIFRICCIÓN 400 ML.	24000400	12x400 ML.	AEROSOL 400 ML.	24,00 €
AEROSOL ANTIGRIPANTE KERAMIC PASTE 400 ML.	22000400	12x400 ML.	AEROSOL 400 ML.	55,34 €
LIMPIADOR INDUSTRIAL ALL CLEAN 500 ML.	23000500	12x500 ML.	AEROSOL 500 ML.	33,36 €
ANTICONGELANTE FLUIDIFICANTE PARA DIESEL 1 L.	62001000	6x1 L.	BOTE DE 1 L.	74,31 €
ANTICONGELANTE FLUIDIFICANTE PARA DIESEL 5 L.	62005000	4x5 L.	LITRO	65,64 €
ANTICONGELANTE FLUIDIFICANTE PARA DIESEL 25 L.	62025000	1x25 L.	LITRO	61,92 €
AEROSOL PROFESIONAL TURBO LIMPIADOR 500 ML.	66000500	12x500 ML.	AEROSOL 500 ML.	34,00 €
AEROSOL LIMPIADOR DE FILTROS DPF 500 ML.	98000500	12x500 ML.	AEROSOL 500 ML.	31,08 €
PROTECTOR REGENERADOR DPF 400 ML.	71000400	12x400 ML.	BOTE DE 400 ML.	32,62 €
PROTECTOR REGENERADOR DPF 1 L.	71001000	6x1 L.	BOTE DE 1 L.	65,22 €
PROTECTOR REGENERADOR DPF 5 L.	71005000	4x5 L.	LITRO	56,29 €
LIMPIADOR FILTROS PARTÍCULAS DPF 1 L.	96001000	6x1 L.	BOTE DE 1 L.	39,53 €
LIMPIADOR FILTROS PARTÍCULAS DPF 5 L.	96005000	4x5 L.	LITRO	33,26 €
LIMPIADOR FILTROS PARTÍCULAS DPF 25 L.	96025000	1x25 L.	LITRO	28,61 €
ENJUAGUE LIMPIADOR PARA FILTROS DPF 1 L.	97001000	6x1 L.	BOTE DE 1 L.	39,53 €
ENJUAGUE LIMPIADOR PARA FILTROS DPF 5 L.	97005000	4x5 L.	LITRO	33,26 €
ENJUAGUE LIMPIADOR PARA FILTROS DPF 25 L.	97025000	1x25 L.	LITRO	28,61 €
TRATAMIENTO PREMIUM PARA COMBUSTIBLE DIESEL 1 L.	10001000	6x1 L.	BOTE DE 1 L.	89,08 €
TRATAMIENTO PREMIUM PARA COMBUSTIBLE DIESEL 5 L.	10005000	4x5 L.	LITRO	83,02 €
TRATAMIENTO PREMIUM PARA COMBUSTIBLE DIESEL 25 L.	10025000	1x25 L.	LITRO	79,36 €
TRATAMIENTO PREMIUM PARA COMBUSTIBLE DIESEL 200 L.	10200000	1x200 L.	LITRO	68,77 €
TRATAMIENTO ANTI-CRISTALIZACIÓN PARA ADBLUE 250 ML.	30000250	12x250 ML.	BOTE DE 250 ML.	29,00 €
TRATAMIENTO ANTI-CRISTALIZACIÓN PARA ADBLUE 5 L.	30005000	4x5 L.	LITRO	87,00 €

RESTAURADOR DE FAROS

P.V.P: 17€/u

Restaurador De Faros

*en tan sólo
2 Minutos*



FAROS COMO NUEVOS

Acabado con capa protectora contra rayos UVA para una larga duración y brillo.

INSTRUCCIONES

ANTES DE EMPEZAR:

No empiece el proceso si el faro está caliente o sucio. Puede enfriarlo y limpiarlo con un paño húmedo.

No empiece el proceso si el faro está rugoso; use un papel de lija húmedo de grano fino para alisarlo (grano 1500 o superior, no incluido). O la esponja abrasiva opcional para faros muy dañados. Una vez el faro esté frío, limpio, liso y seco puede empezar.

Paso 1:

Abra el primer sobre amarillo, desdóblelo y páselo frotando por el primer faro.

Luego seque el faro con un trozo de papel (de secar manos).

Paso 2:

Abra el segundo sobre amarillo, desdóblelo y páselo por el segundo faro.

Seque el faro con un trozo de papel. Los faros deben quedar totalmente secos y mates.

Paso 3:

Abra el sobre naranja, y sin desdoblarlo páselo como un pincel, suavemente por ambos faros. Quedarán como nuevos.

IMPORTANTE:

Al terminar no toque los faros y evite que se humedezcan durante 30-40 minutos.

No conduzca hasta que esté seco. Para acelerar el secado, los faros pueden estar encendidos.

No lave el coche hasta al menos 24 horas después.



3 Simples Pasos

con toallitas desechables

- 1 Limpie 2 Seque 3 Abrillante



Ref: 2032433

*Si desea un expositor con televisión pregúntenos cómo conseguirlo!

2032433AA

P.V.P: 1,80€

ESPONJA ABRASIVA OPCIONAL PARA FAROS MUY DAÑADOS



Vídeo de instrucciones en:
www.restauradordefaros.com

TABLA DE CONTENIDOS



DESCRIPCIÓN	PÁGINA
LLAVES CARRACA	57
LLAVES DINAMOMÉTRICAS / HEX. y TORX	58
MALETINES	59-61
CARROS DE HERRAMIENTAS	62-63
LLAVES Y MÓDULOS	63-73
VASOS CORTOS	74
VASOS LARGOS	75

DESCRIPCIÓN	PÁGINA
VARIEDAD / ACCESORIOS	76-78
VASOS DE IMPACTO	79-81
REDUCTORES DE IMPACTO	82
ARTICULACIONES DE IMPACTO	82
EXTRACTORES	83
VASOS PUNTA IMPACTO	83
PUNTAS 10mm / VASOS PUNTA DE 1/4"	84-85

MEDIDAS MODULOS DE HERRAMIENTAS

S 435 x 85 mm.

L 435 x 180 mm.

M 365 x 145 mm.

X 415 x 270 mm.

LLAVE CARRACA

48D.

Referencia	□	L (m/m)	D (m/m)	W (m/m)	Apriete (Nw.)	P.V.P.
RH-A83248	1/4"	148	25	26	62	15 €
RH-A83348	3/8"	197	33	32	202	18 €
RH-A83448	1/2"	275	42	40	512	24 €

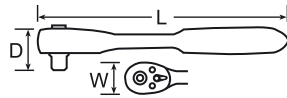

LLAVE CARRACA CON MANGO GIRATORIO

60D.

Referencia	□	L (m/m)	D (m/m)	W (m/m)	Apriete (Nw.)	P.V.P.
RH-G83260	1/4"	183	25	27	62	49 €
RH-G83460	1/2"	293	39	43	512	Descat.



LLAVE CARRACA EXTENSIBLE

48D.

Referencia	□	L (m/m)	D (m/m)	W (m/m)	Apriete (Nw.)	P.V.P.
RH-D85248	1/4"	150-200	14	26	62	24 €
RH-D85448	1/2"	305-445	21	39	512	35 €

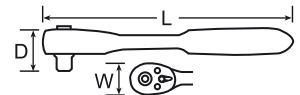

MANGO ARTICULADO

Referencia	A	B (m/m)	P.V.P.
BB-04650A	1/2"	480	33 €
BB-06650A	3/4"	480	38 €



LLAVE DINAMOMÉTRICA

Referencia	A	B (m/m)	Capacity (Nm)	P.V.P.
TW-03060B	3/8"	390	5 ~60	84 €
TW-04210B	1/2"	515	42 ~210	126 €
TW-04350B	1/2"	580	70 ~350	148 €



KW-63109S

P.V.P: 12€

JUEGO DE 9 LLAVES HEXAGONALES

A (mm)	B (mm)	C (mm)
1,5	15	46
2	18	52
2,5	20	58
3	23	66
4	28	73

A (mm)	B (mm)	C (mm)
5	32	84
6	36	94
8	43	107
10	48	120

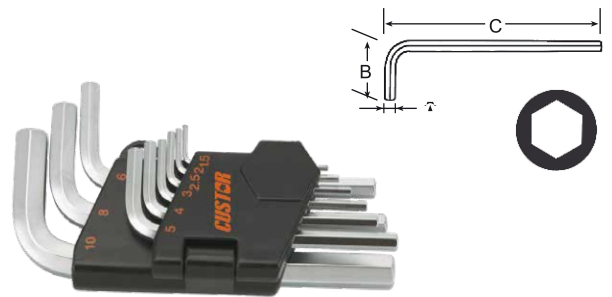

KW-65209S

P.V.P: 22€

9 PIEZAS - LLAVES HEXAGONALES LARGAS

A (mm)	B (mm)	C (mm)
1,5	15	92
2	16	104
2,5	20	115
3	23	130
4	29	145

A (mm)	B (mm)	C (mm)
5	33	166
6	38	187
8	44	212
10	50	237

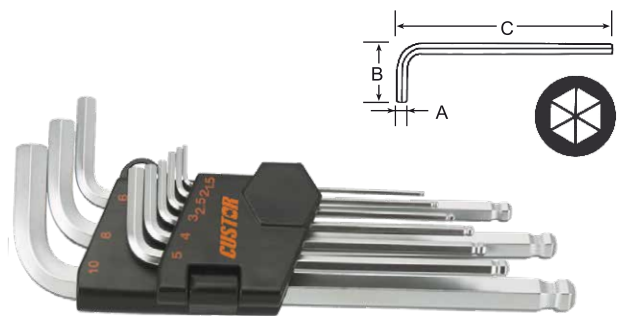

KW-65309S

P.V.P: 23€

9 PIEZAS - LLAVES TORX LARGAS

A (mm)	B (mm)	C (mm)
T10	20	90
T15	20	105
T20	22	117
T25	26	130
T27	30	146



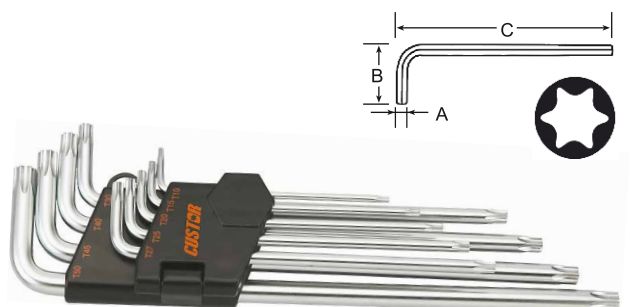







A (mm)	B (mm)	C (mm)
T30	34	166
T40	40	187
T45	44	210
T50	50	233



BS-21044K

P.V.P: 64€

44 PIEZAS - JUEGO DE PUNTAS











-   3/8" x 10mm
-  (10mm x 30mmL.) 8, 9mm
-  (10mm x 30mmL.) T20, T25, T27, T30, T40, T45, T50, T55, T60
-  (10mm x 30mmL.) M-5, M-6, M-7, M-8, M-10, M-12
-  (10mm x 30mmL.) H4, H5, H6, H7, H8, H10, H12
-  (10mm x 75mmL.) H4, H5, H6, H7, H8, H10, H12
-  (10mm x 75mmL.) T20, T25, T27, T30, T40, T45, T50, T55, T60
-  1/2" x 10mm
-  (10mm x 30mmL.) PH1, PH2, PH3



BS-0044K

P.V.P: 89€

44 PIEZAS - JUEGO DE PUNTAS CAJA METÁLICA

-  (10mm x 30mmL.) T20, T25, T30, T40, T45, T50, T55, T60
-  (10mm x 30mmL.) M-5, M-6, M-7, M-8, M-10, M-12
-  (10mm x 30mmL.) H4, H5, H6, H7, H8, H10, H12
-  (10mm x 75mmL.) H4, H5, H6, H7, H8, H10, H12
-  (10mm x 75mmL.) T20, T25, T30, T40, T45, T50, T55, T60
-  (10mm x 75mmL.) M-5, M-6, M-8, M-10, M-12
-  1/2" T-80
-  1/2" T-70
-  1/2" x 10mm
-  3/8" x 10mm



ADCKM-901B

P.V.P: 39€

27 PIEZAS - JUEGO DE MINI CARRACA ALUMINIO 1/4" (36 DIENTES)

Ref: 2032107











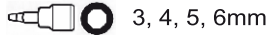

Vasos: 4 - 5 - 6 - 8 - 10 - 13 mm.
 Phillips: #0, #1, #2, #3
 Planas: 2,0 - 3,0 - 4,0 - 5,0 - 6,0 mm.
 Torx: T6, T8, T10, T15, T20
 Hex: H2,5 - H3,0 - H3,5
 Pozidriv: PZ1, PZ2, PZ3
 Material vasos: OBV30
 Material puntas: S2

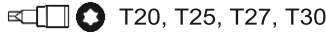
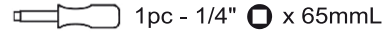

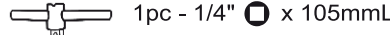
TK-02027K

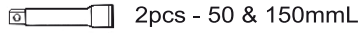
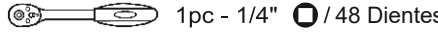
P.V.P: 69€

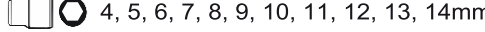
27 PIEZAS - JUEGO CARRACA 1/4"











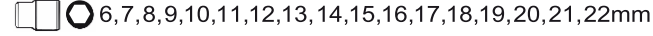

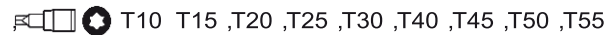
-  1pc - 1/4"   PH2
-  3, 4, 5, 6mm  5.5mm
-  T20, T25, T27, T30
-  1pc - 1/4"  x 65mmL
-  1pc - 1/4"  x 105mmL
-  2pcs - 50 & 150mmL
-  1pc - 1/4"  / 48 Dientes
-   4, 5, 6, 7, 8, 9, 10, 11, 12, 13, 14mm

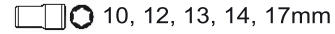

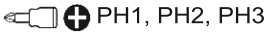
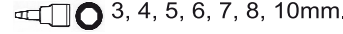
TK-03052K

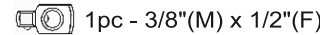
P.V.P: 149€

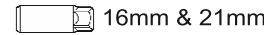
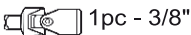
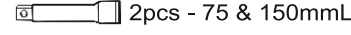
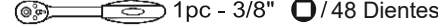
52 PIEZAS - JUEGO CARRACA 3/8"











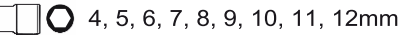
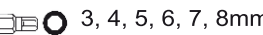
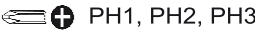
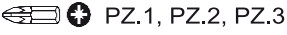
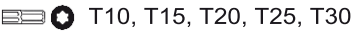
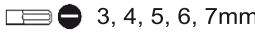





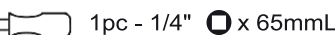

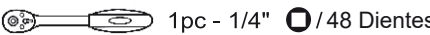
-   6, 7, 8, 9, 10, 11, 12, 13, 14, 15, 16, 17, 18, 19, 20, 21, 22mm
-   T10 T15 T20 T25 T30 T40 T45 T50 T55
-   10, 12, 13, 14, 17mm  PH1, PH2, PH3
-   3, 4, 5, 6, 7, 8, 10mm.  PZ.1, PZ.2
-  1pc - 3/8"(M) x 1/2"(F)  5.5, 6.5mm
-  16mm & 21mm  1pc - 3/8"
-  2pcs - 75 & 150mmL
-  1pc - 3/8"  / 48 Dientes

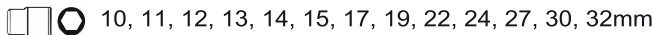
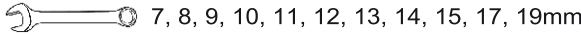

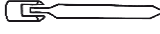
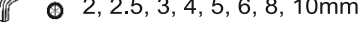
TK-02478K

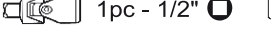
P.V.P: 286€

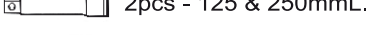
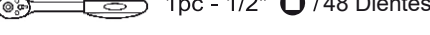
78 PIEZAS - JUEGO CARRACAS 1/4 Y 1/2"

- 1/4"**   4, 5, 6, 7, 8, 9, 10, 11, 12mm  3, 4, 5, 6, 7, 8mm
-  PH1, PH2, PH3  PZ.1, PZ.2, PZ.3
-  T10, T15, T20, T25, T30  3, 4, 5, 6, 7mm
-  1pc - 1/4"  x 6.5mm Coupler  1pc - 1/4" 
-  1pc - 1/4" 
-  1pc - 1/4"  x 65mmL
-  1pc - 1/4"  / 48 Dientes
- 1/2"**   10, 11, 12, 13, 14, 15, 17, 19, 22, 24, 27, 30, 32mm
-   7, 8, 9, 10, 11, 12, 13, 14, 15, 17, 19mm
-   8 x 9, 10 x 11, 12 x 13, 14 x 15mm
-   2, 2.5, 3, 4, 5, 6, 8, 10mm
-  1pc - 1/2"  x 21mm
-  2pcs - 125 & 250mmL.
-  1pc - 1/2"  / 48 Dientes



TK-06014K

P.V.P: 208€

JUEGO CARRACA 3/4" (14 PIEZAS)

Ref: 2032426

Incluye:

carraca 3/4" - 500mm. 24D
vasos hex. 22 - 24 - 27 - 30 - 32 - 36 - 38 - 41 - 46 - 50
alargos: 100 y 200mm.
mango corredizo 450mm.



TK-08015K

P.V.P: 559€

JUEGO CARRACA 1" (15 PIEZAS)

Ref: 2032425

Incluye:

carraca 1" - 670mm. 24D
vasos hex. 36 - 41 - 46 - 50 - 55 - 60 - 65 - 70 - 75 - 80
alargos: 200 y 400mm.
adaptador para mango corredizo



TB-99001D

P.V.P: 24€*

SOPORTE ROLLO DE PAPEL



TB-99001B

P.V.P: 33€*

SOPORTE HERRAMIENTAS



TB-88007A

P.V.P: 425€*

COFRE DE 7 CAJONES



- Guías reforzadas con cojinetes
- Grosor chapa cajones: 0,8mm.
- Grosor chapa estructura: 1,0mm.



TB-99005A

P.V.P: 510€*

CARRO HERRAMIENTAS 5 CAJONES



- Guías reforzadas con cojinetes
- Grosor chapa cajones: 0,8mm.
- Grosor chapa estructura: 1,0mm.
- Ruedas de PU Ø125 x 50mm.

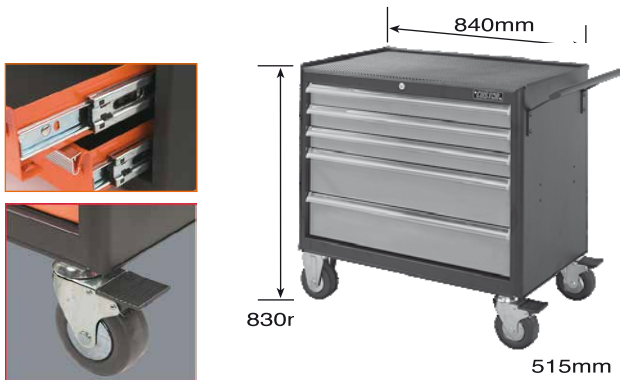

TB-99007A

P.V.P: 690€*

CARRO HERRAMIENTAS 7 CAJONES



- Guías reforzadas con cojinetes
- Grosor chapa cajones: 0,8mm.
- Grosor chapa estructura: 1,0mm.
- Ruedas de PU Ø125 x 50mm.

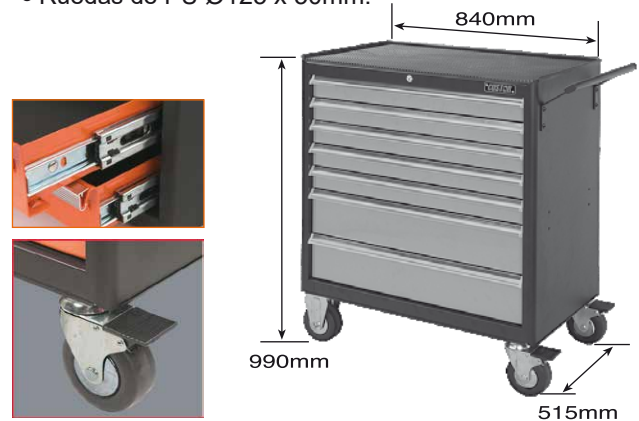

TB-99007C

P.V.P: 639€*

CARRO HERRAMIENTAS 7 CAJONES

- Guías reforzadas con cojinetes
- Grosor chapa cajones: 0,8mm.
- Grosor chapa estructura: 1,0mm.
- Ruedas de PU Ø100 x 30mm.

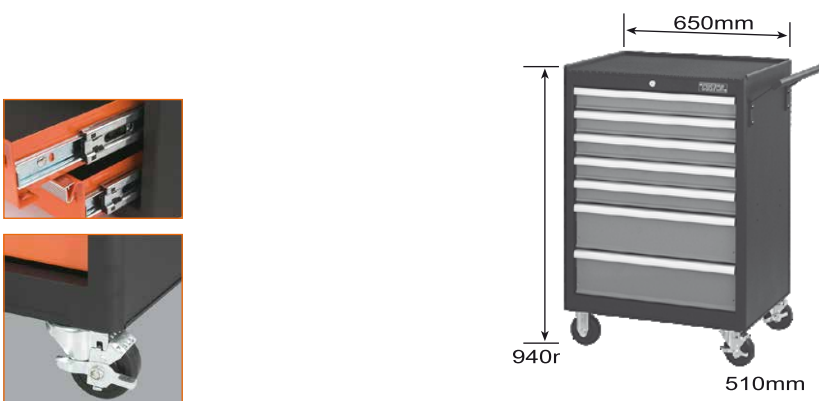

TB-99007C-DOT

P.V.P: 1128€*

OFERTA CARRO DE HERRAMIENTAS CON DOTACIÓN

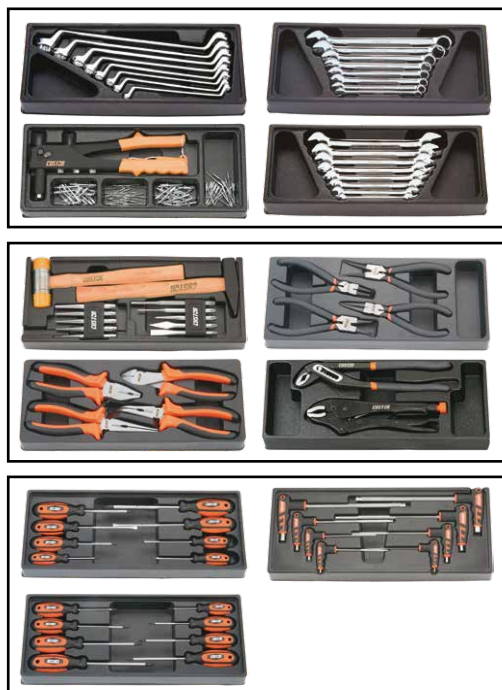

GRATIS por la compra del carro con dotación:
MALETIN DE HERRAMIENTAS (total: 182 Piezas)

TORNILLOS DE BANCO

Referencia				P.V.P.
SV-62004A	100mm.	100mm.	360°	139€*
SV-62005A	125mm.	125mm.	360°	175€*
SV-62006A	150mm.	150mm.	360°	209€*



TK-02017S

P.V.P: 53€

M

M1 - 17 PIEZAS - CARRACA 1/4"

- 4, 5, 6, 7, 8, 9, 10, 11, 12, 13, 14mm
- 1pc - 1/4" 1pc - 1/4" x 105mmL
- 1pc - 1/4" / 48 Dientes
- 1pc - 1/4" x 65mmL
- 2pcs - 50 & 150mmL.



TK-04022S

P.V.P: 110€

M

M3 - 22 PIEZAS - CARRACA 1/2"

- 10, 11, 12, 13, 14, 15, 16, 17, 18, 19, 20, 21, 22, 24, 27, 30, 32mm
- 1pc - 3/8"(M) x 1/2"(F)
- 2pcs - 125 & 250mmL.
- 1pc - 1/2" / 48 Dientes
- 1pc - 1/2"



FS-81005S

P.V.P: 63€

L

M4 - 5 PIEZAS - LIMAS ACERO ALTO-CARBONO

Descripción		L.(m/m)
	Punta plana	200
	Media caña	200
	Punta redonda	200
	Punta cuadrada	200
	Punta triangular	200















HP-13012S

P.V.P: 88€

L

M7 - 12 PIEZAS - MARTILLOS Y BOTADORES

Descripción	L.(m/m)	Descripción	L.(m/m)
	300		120
	320		120
	120		150
	120		165
	120		130
	120		130



KW-15008S

P.V.P: 51€

L

M10 - 8 PIEZAS - LLAVES ALLEN CON EMPUÑADURA

	A1 / A2	B1 / B2	C1 / C2
	(mm)	(mm)	(mm)
	2	100 / 9	140 / 65
	2.5	100 / 9	140 / 65
	3	100 / 9	140 / 65
	4	150 / 12	200 / 80
	5	155 / 12	200 / 80
	6	205 / 12	260 / 90
	8	205 / 17	260 / 95
	10	210 / 17	265 / 95

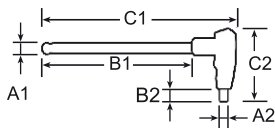

KW-16008S

P.V.P: 52€

L

M11 - 8 PIEZAS - LLAVES TORX CON EMPUÑADURA

	A1 / A2	B1 / B2	C1 / C2
	(mm)	(mm)	(mm)
	T-10	100 / 10	140 / 65
	T-15	100 / 10	140 / 65
	T-20	100 / 10	140 / 65
	T-25	105 / 10	150 / 80
	T-27	105 / 10	150 / 80
	T-30	150 / 15	200 / 100
	T-40	150 / 15	200 / 105
	T-50	160 / 20	215 / 100

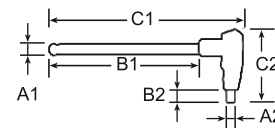

HR-67004S

P.V.P: 30€

M

M32 - REMACHADORA MANUAL

Descripción	Tamaño (mm)	Cantidad
 BOQUILLA	2.4	1
	3.2	1
	4.0	1
	4.8	1

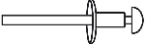
Descripción	Tamaño (mm)	Cantidad
 REMACHE	2.4	25
	3.2	25
	4.0	25
	4.8	25



HR-67005S

P.V.P: 67€

M

J3 - REMACHADORA DE TUERCAS

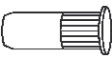
Descripción	Tamaño (mm)	Cantidad
 BOQUILLA	3 - 4 - 5 - 6 - 8	1 de cada
 REMACHE	3 - 4 - 5 - 6 - 8	10 de cada



ND-81709S

P.V.P: 71€

L

M8 - 9 PIEZAS - DESTORNILLADORES DE VASO

	A (mm)	B (mm)	C (mm)
	6	35	125
	7	35	125
	8	35	125
	9	35	125
	10	35	125
	11	35	125
	12	35	125
	13	35	125
	14	35	125

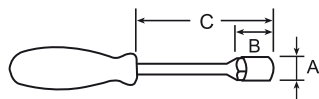

ND-51309S

P.V.P: 67€

X

M9 - 9 PIEZAS - LLAVE DE VASO EN T

	A (mm)	B (mm)	C (mm)
	5	50	230
	6	50	230
	7	50	230
	8	50	230
	9	50	230
	10	50	230
	11	50	230
	12	50	230
	13	50	230

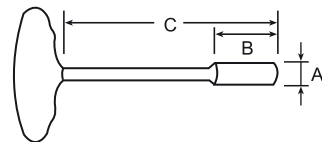

CP-06004S

P.V.P: 74€

M

M15 - 4 PIEZAS - ALICATES ANILLAS



CP-08004S

P.V.P: 84€

M

M16 - 4 PIEZAS - ALICATES PROFESIONALES



CP-060-001

P.V.P: 21€

ALICATE EXTERIOR RECTO 180mm



CP-060-002

P.V.P: 21€

ALICATE INTERIOR RECTO 180mm



CP-080-001

P.V.P: 23€

ALICATE RECTO 200mm



CP-080-002

P.V.P: 24€

ALICATE CURVO 200mm



CP-060-003

P.V.P: 22€

ALICATE EXTERIOR CURVO 170mm



CP-060-004

P.V.P: 22€

ALICATE INTERIOR CURVO 170mm



CP-080-003

P.V.P: 23€

ALICATE UNIVERSAL 175mm



CP-080-004

P.V.P: 23€

ALICATE DE CORTE 175mm





CP-10002S

P.V.P: 44€

M

M6 - 2 PIEZAS - TENAZA Y MORDAZA

Ref.	Descripción	L.(m/m)	P.V.P.
CP-100-001	 Tenaza	255	23,00 €
CP-100-002	 Mordaza	210	23,00 €



SD-81108S

P.V.P: 38€

M12 - 8 PIEZAS - DESTORNILLADORES PLANOS
PLANOS: 3 - 4 - 5,5 - 6,5
PH: PH0 - PH1 - PH2 - PH3

L



SD-81114S

P.V.P: 58€

M14 - 14 PIEZAS - DESTORNILLADORES PLANOS
PLANOS: 3 - 3,5 - 4 - 5,5/38 - 5,5/125 - 6,5/38 - 6,5/150 - 8
PH: PH0 - PH1/38 - PH1/80 - PH2/38 - PH2/100 - PH3

L



DESTORNILLADORES PLANOS

Ref.	A / B (mm)	P.V.P.	Ref.	A / B (mm)	P.V.P.
SD811S30075	3.0 / 75	4,00 €	SD811S55125	5.5 / 125	5,60 €
SD811S35100	3.5 / 100	5,40 €	SD811S65038	6.5 / 38	5,60 €
SD811S40100	4.0 / 100	5,40 €	SD811S65150	6.5 / 150	6,50 €
SD811S55038	5.5 / 38	5,40 €	SD811S80175	8.0 / 175	8,00 €

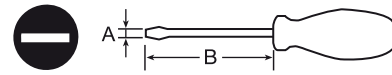

DESTORNILLADORES PHILLIPS

Ref.	A / B (mm)	P.V.P.	Ref.	A / B (mm)	P.V.P.
SD811PH0060	PH0 / 60	4,10 €	SD811PH2038	PH2 / 38	4,80 €
SD811PH1038	PH1 / 38	4,50 €	SD811PH2100	PH2 / 100	5,50 €
SD811PH1080	PH1 / 80	4,60 €	SD811PH3150	PH3 / 150	7,60 €

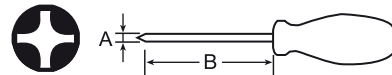

SD-81508S

P.V.P: 38€

M13 - 8 PIEZAS - DESTORNILLADORES TORX

L

A / B (mm)	A / B (mm)
T8 / 60	T25 / 100
T10 / 80	T27 / 115
T15 / 80	T30 / 115
T20 / 100	T40 / 130

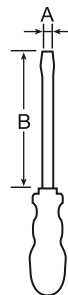

DESTORNILLADORES TORX

Ref.	A / B (mm)	P.V.P.
SD815T08060	T8 / 60	3,90 €
SD815T10080	T10 / 80	4,30 €
SD815T15080	T15 / 80	4,30 €
SD815T20100	T20 / 100	4,50 €
SD815T25100	T25 / 100	4,60 €
SD815T27115	T27 / 115	5,20 €
SD815T30115	T30 / 115	5,20 €
SD815T40130	T40 / 130	6,00 €

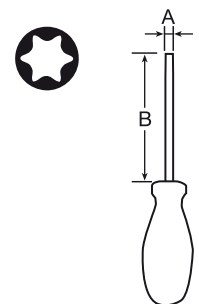

SD-81908S

P.V.P: 54€

L

M22 - 8 PIEZAS - DESTORNILLADORES AISLADOS

A / B (mm)	+	A / B (mm)
4.0 / 100	+	PH1 / 80
5.5 / 125		PH2 / 100
6.5 / 150	*	PZ1 / 80
8.0 / 175		PZ2 / 100

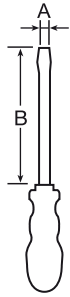

SD-81304S

P.V.P: 25€

S

M24 - 4 PIEZAS - DESTORNILLADORES TORX

A / B (mm)
T10 / 80
T15 / 80
T20 / 100
T25 / 100

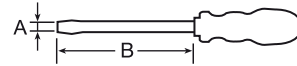

WS-23208S

P.V.P: 60€

M

M18 - 8 PIEZAS - LLAVES FIJAS
(6x7 - 8x9 - 10x11 - 12x13 - 14x15 - 16x17 - 18x19 - 20x22)



WS-23211S

P.V.P: 109€

L

M19 - 11 PIEZAS - LLAVES FIJAS
(6x7 - 8x9 - 10x11 - 12x13 - 14x15 - 16x17 - 18x19 - 20x22 - 21x23 - 24x27 - 30x32)



LLAVES FIJAS

Referencia	A1 X A2 (m/m)	B (m/m)	P.V.P.
2320607	6 x 7	122	5,20 €
2320809	8 x 9	140	5,30 €
2321011	10 x 11	156	5,80 €
2321213	12 x 13	172	6,30 €
2321415	14 x 15	190	7,00 €
2321617	16 x 17	204	8,70 €
2321819	18 x 19	221	10,60 €
2322022	20 x 22	237	12,90 €
2322123	21 x 23	247	15,00 €
2322427	24 x 27	263	18,00 €
2323032	30 x 32	298	23,00 €

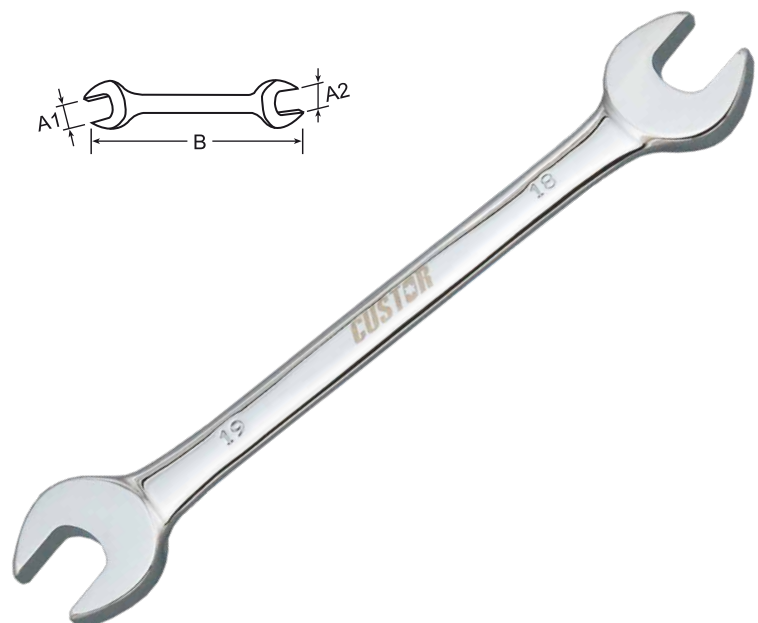
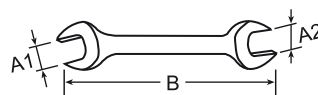

WS-32408S

P.V.P: 59€

M20 - 8 PIEZAS - LLAVES COMBINADAS
(8x8 - 9x9 - 10x10 - 11x11 - 13x13 - 14x14 -
17x17 - 19x19)

M



WS-32416S

P.V.P: 131€

M21 - 16 PIEZAS - LLAVES COMBINADAS
(6x6 - 7x7 - 8x8 - 9x9 - 10x10 - 11x11 - 12x12 - 13x13 -
14x14 - 16x16 - 17x17 - 18x18 - 19x19 - 20x20 -
22x22 - 24x24)

X



WS-32403S

P.V.P: 83€

M41 - 3 PIEZAS - LLAVES COMBINADAS
(27x27 - 30x30 - 32x32)

L



LLAVES COMBINADAS

Referencia	A1 X A2 (m/m)	B (m/m)	P.V.P.
3240606	6 x 6	129	5,40 €
3240707	7 x 7	135	5,60 €
3240808	8 x 8	142	6,10 €
3240909	9 x 9	155	6,30 €
3241010	10 x 10	161	6,50 €
3241111	11 x 11	168	6,80 €
3241212	12 x 12	174	7,30 €
3241313	13 x 13	180	8,00 €
3241414	14 x 14	193	8,50 €
3241515	15 x 15	200	9,40 €
3241616	16 x 16	207	9,40 €
3241717	17 x 17	227	10,40 €
3241818	18 x 18	239	11,00 €
3241919	19 x 19	250	12,00 €
3242020	20 x 20	259	13,30 €
3242121	21 x 21	271	15,30 €
3242222	22 x 22	294	15,50 €
3242424	24 x 24	313	16,60 €
3242727	27 x 27	362	22,50 €
3243030	30 x 30	394	26,00 €
3243232	32 x 32	429	30,50 €

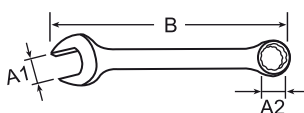

WS-53208S

P.V.P: 98€

L

M27 - 8 PIEZAS - LLAVES ACODADAS

(6x7 - 8x9 - 10x11 - 12x13 - 14x15 - 16x17- 18x19 - 20x22)



WS-53210S

P.V.P: 146€

M

M28 - 10 PIEZAS - LLAVES ACODADAS

(6x7 - 8x9 - 10x11 - 12x13 - 14x15 - 16x17- 18x19 - 20x22 - 24x27 - 30x32)

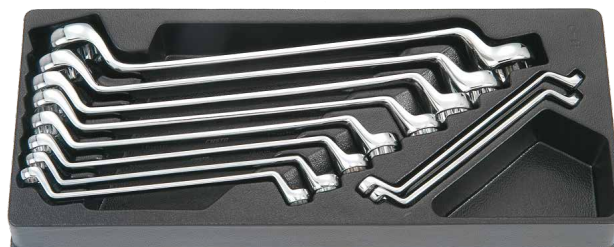

LLAVES ACODADAS

Referencia	A1 X A2 (m/m)	B (m/m)	P.V.P.
5320607	6 x 7	168	8,50 €
5320809	8 x 9	183	9,80 €
5321011	10 x 11	198	10,90 €
5321213	12 x 13	217	11,90 €
5321415	14 x 15	239	13,90 €
5321617	16 x 17	260	15,50 €
5321819	18 x 19	292	16,50 €
5322022	20 x 22	318	19,30 €
5322427	24 x 27	345	24,00 €
5323032	30 x 32	370	30,50 €

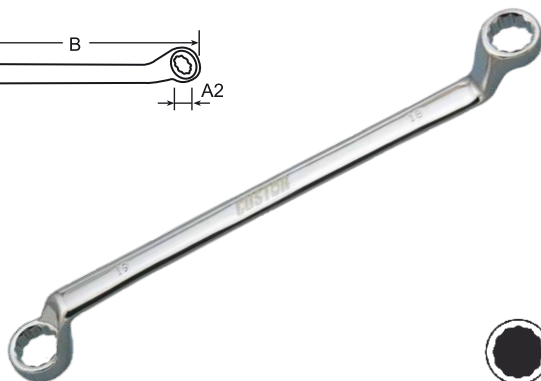
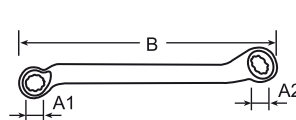

WS-72405S

P.V.P: 105€

M

M37 - 5 PIEZAS - LLAVES EXTRA-LARGAS

(8x10 - 12x14 - 13x15 - 16x18 - 17x19)



WS-72408S

P.V.P: 173€

L

M30 - 8 PIEZAS - LLAVES EXTRA-LARGAS

(8x10 - 10x11 - 12x14 - 13x15 - 14x17 - 16x18 - 17x19 - 22x24)



LLAVES ESTRELLA EXTRA-LARGAS

Referencia	A1 X A2 (m/m)	B (m/m)	P.V.P.
7240810	8 x 10	235	15,00 €
7241011	10 x 11	287	16,80 €
7241214	12 x 14	330	20,00 €
7241315	13 x 15	370	23,00 €
7241417	14 x 17	370	23,00 €
7241618	16 x 18	405	26,50 €
7241719	17 x 19	405	26,50 €
7242224	22 x 24	435	36,00 €

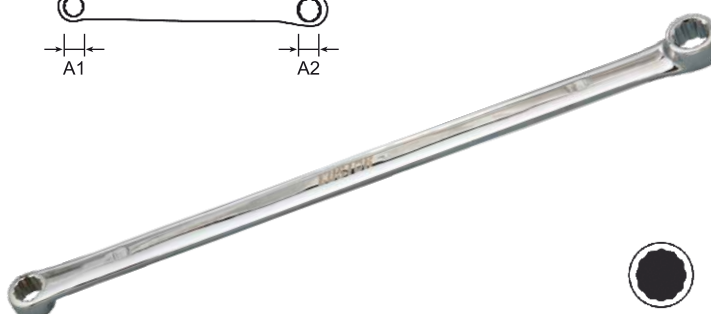
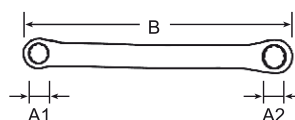

WS-41708S

P.V.P: 86€

M26 - 8 PIEZAS - CARRACAS ACODADAS
(6x7 - 8x9 - 10x11 - 12x13 - 14x15 - 16x18 - 17x19 - 21x22)

L



WS-62208S

P.V.P: 102€

M29 - 8 PIEZAS - LLAVES VASO ARTICULADAS
(6x7 - 8x9 - 10x11 - 12x13 - 14x15 - 16x17 - 18x19 - 20x22)

M



LLAVES CARRACAS ACODADAS

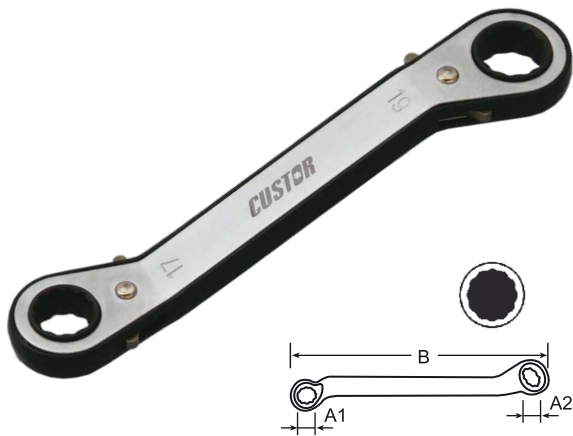

Referencia	A1 X A2 (m/m)	B (m/m)	P.V.P.
4170607	6 x 7	113	8,00 €
4170809	8 x 9	133	9,00 €
4171011	10 x 11	140	9,00 €
4171213	12 x 13	172	12,00 €
4171415	14 x 15	172	12,00 €
4171618	16 x 18	205	15,00 €
4171719	17 x 19	205	15,00 €
4172122	21 x 22	235	15,50 €

LLAVES VASO ARTICULADAS

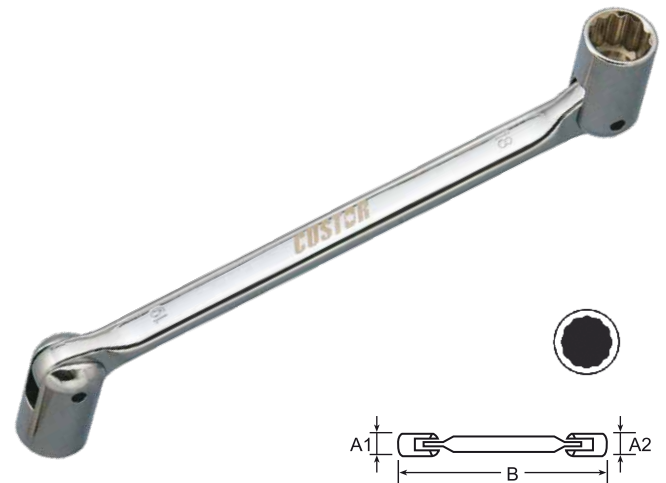

Referencia	A1 X A2 (m/m)	B (m/m)	P.V.P.
6220607	6 x 7	180	10,50 €
6220809	8 x 9	180	10,50 €
6221011	10 x 11	200	10,50 €
6221213	12 x 13	220	12,50 €
6221415	14 x 15	235	14,00 €
6221617	16 x 17	254	16,50 €
6221819	18 x 19	275	18,50 €
6222022	20 x 22	305	26,50 €

WS-23310S

P.V.P: 125€

MC2 - 10 PIEZAS - JUEGO DE LLAVES FIJAS
EXTRA FINAS 6x7, 8x9, 10x11, 12x13, 14x15, 16x17, 18x19, 20x22, 21x23, 22x24mm.

L



WS-41108S

P.V.P: 109€

M5 - 8 PIEZAS - LLAVES COMBINADAS
CARRACA 72 D (8x8 - 9x9 - 10x10 - 11x11 - 12x12 -
13x13 - 17x17 - 19x19)

M



WS-41508S

P.V.P: 151€

M40 - 8 PIEZAS - LLAVES COMBINADAS
CARRACA ARTICULADAS 72 D (8x8 - 9x9 - 10x10 -
11x11 - 13x13 - 14x14 - 17x17 - 19x19)

M



LLAVES COMBINADAS CARRACA 72 D.

Referencia	A1 X A2 (m/m)	B (m/m)	P.V.P.
4110808	8 x 8	136	12,50 €
4110909	9 x 9	143	12,50 €
4111010	10 x 10	160	13,00 €
4111111	11 x 11	168	13,50 €
4111212	12 x 12	174	14,00 €
4111313	13 x 13	180	15,00 €
4111414	14 x 14	193	16,00 €
4111515	15 x 15	200	16,50 €
4111717	17 x 17	233	18,50 €
4111919	19 x 19	250	20,00 €

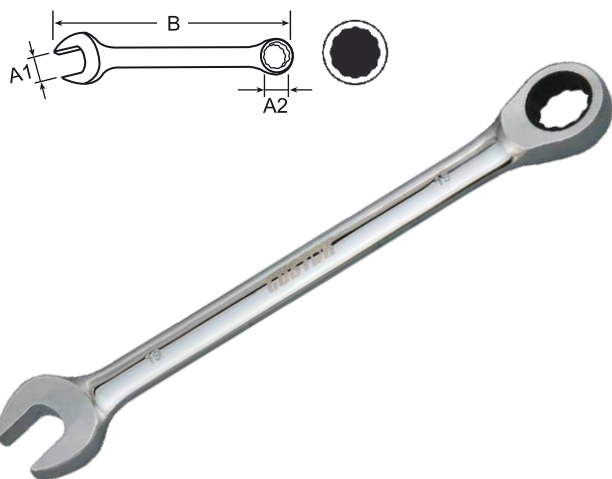

LLAVES CARRACA COMBINADAS ARTICULADAS 72 D.

Referencia	A1 X A2 (m/m)	B (m/m)	P.V.P.
4150808	8 x 8	136	17,50 €
4150909	9 x 9	143	17,50 €
4151010	10 x 10	160	18,50 €
4151111	11 x 11	168	18,50 €
4151212	12 x 12	174	20,50 €
4151313	13 x 13	180	20,50 €
4151414	14 x 14	193	21,10 €
4151515	15 x 15	200	25,00 €
4151616	16 x 16	216	25,00 €
4151717	17 x 17	233	25,00 €
4151818	18 x 18	239	26,50 €
4151919	19 x 19	250	26,50 €

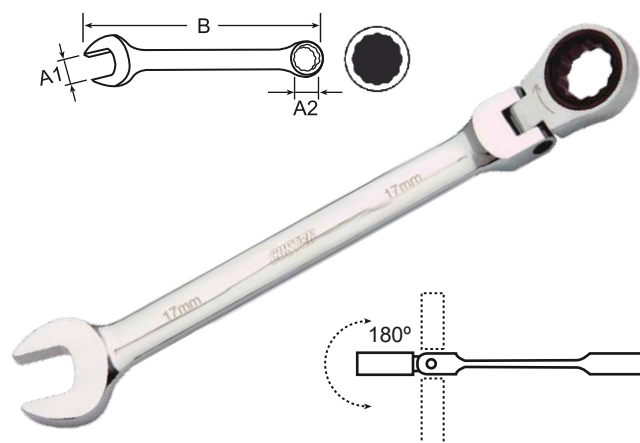

CS-10603S

M23 - ALICATE TERMINALES

P.V.P: 109€

L

Numero de pieza		Capacidad	Cantidad
	T1	22~16 AWG. / 0.3~1.25mm ²	100
	T2	16~14 AWG. / 1.25~2.0mm ²	100
	T3	12~10 AWG. / 2.05~5.5mm ²	100
	T4	22~18 AWG. / 0.3~0.8mm ²	100
	T5	22~16 AWG. / 0.3~1.25mm ²	100
	T6	16~14 AWG. / 1.25~2.0mm ²	100

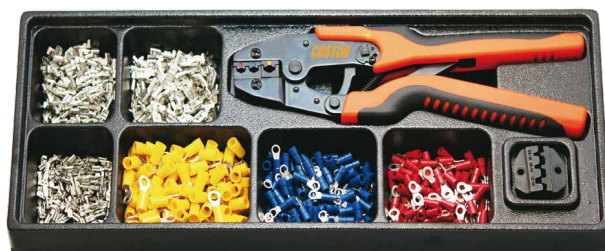

WS-11003S

P.V.P: 90€

M31 - 3 PIEZAS - LLAVES INGLESAS
(200 - 250 - 300)

M



LLAVES INGLESAS

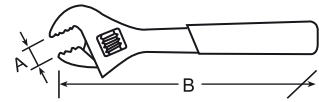

Referencia	A (m/m)	B (m/m)	P.V.P.
1100200	28,6	200	27,00 €
1100250	32,8	250	35,00 €
1100300	38,1	300	42,00 €

LLAVES INGLESAS CARRACA

Referencia	A Apertura maxima	B (m/m)	P.V.P.
FW-08245	24,5 mm.	200	22,50 €
FW-10300	30 mm.	250	26,50 €

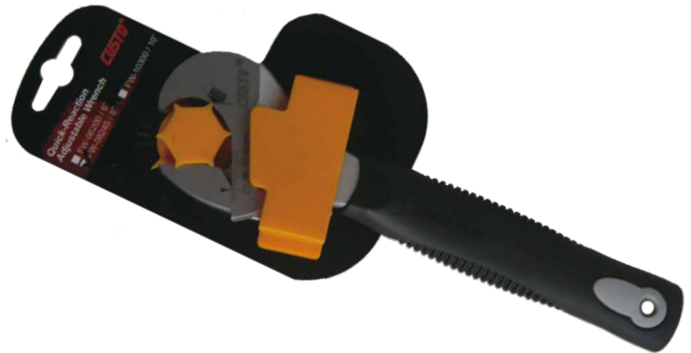
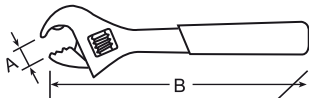

HN-GW-2AC

P.V.P: 29€

LLAVE ESTRELLA PLANA
CON CARRACA MULTIUSOS (8-10-11 y 13mm.)

Ref: 2032297

HN-GW-2FG

P.V.P: 35€

LLAVE ESTRELLA PLANA
CON CARRACA MULTIUSOS (14-16-17 y 19mm.)

Ref: 2032299



24en1



PARA TUERCAS
Y TORNILLOS:

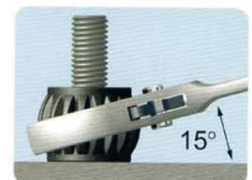

Esta llave se puede usar para tornillos y tuercas en milímetros, en pulgadas, torx, etc...

Gracias a su inclinación se puede acceder a tornillos de difícil acceso e incluso tornillos pasantes.

CUSTOMER Vasos cortos de 6, 12 caras y torx

VASOS HEXAGONALES CORTOS

Ø 1/4"

Referencia	A (m/m)	B (m/m)	P.V.P.
0225040	4	25	1,90 €
0225050	5	25	1,90 €
0225055	5,5	25	1,90 €
0225060	6	25	1,90 €
0225070	7	25	2,00 €
0225080	8	25	2,00 €
0225090	9	25	2,00 €
0225100	10	25	2,20 €
0225110	11	25	2,30 €
0225120	12	25	2,30 €
0225130	13	25	2,50 €
0225140	14	25	2,80 €

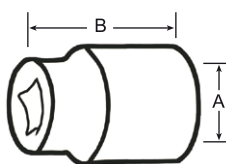

Ø 3/8"

Referencia	A (m/m)	B (m/m)	P.V.P.
0328080	8	28	2,10 €
0328100	10	28	2,10 €
0328110	11	28	2,10 €
0328120	12	28	2,10 €
0328130	13	28	2,30 €
0328140	14	28	2,30 €
0328150	15	28	2,40 €
0328160	16	28	2,40 €
0330170	17	30	2,70 €
0330180	18	30	3,00 €
0330190	19	30	3,00 €

Ø 1/2"

Referencia	A (m/m)	B (m/m)	P.V.P.
0438080	8	38	3,30 €
0438100	10	38	3,30 €
0438110	11	38	3,30 €
0438120	12	38	3,30 €
0438130	13	38	3,40 €
0438140	14	38	3,40 €
0438150	15	38	3,50 €
0438160	16	38	3,50 €
0438170	17	38	3,80 €
0438180	18	38	4,10 €
0438190	19	38	4,10 €
0438200	20	38	5,30 €
0438210	21	38	5,30 €
0438220	22	38	5,30 €
0438230	23	38	5,70 €
0438240	24	38	5,70 €
0442260	26	42	6,60 €
0442270	27	42	7,00 €
0445300	30	45	8,30 €
0445320	32	45	9,00 €

VASOS CORTOS 12 CARAS 1/2"

Referencia	A (m/m)	B (m/m)	P.V.P.
1438080	8	38	3,40 €
1438100	10	38	3,40 €
1438110	11	38	3,40 €
1438120	12	38	3,40 €
1438130	13	38	3,50 €
1438140	14	38	3,50 €
1438150	15	38	3,50 €
1438170	17	38	4,10 €
1438190	19	38	4,10 €
1438220	22	38	5,40 €
1438240	24	38	6,00 €
1438270	27	42	7,10 €
1438300	30	45	8,50 €
1438320	32	45	9,10 €

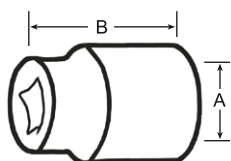

VASOS TORX CORTOS 1/4"

Referencia	A (m/m)	B (m/m)	P.V.P.
0504025	E4	25	3,30 €
0505025	E5	25	3,30 €
0506025	E6	25	3,30 €
0507025	E7	25	3,50 €
0508025	E8	25	3,70 €
0510025	E10	25	4,00 €
0511025	E11	25	4,00 €

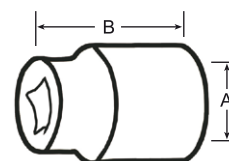

VASOS HEXAGONALES LARGOS

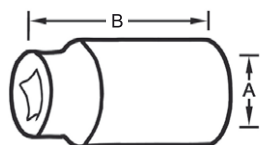

□ 1/4"

Referencia	A (m/m)	B (m/m)	P.V.P.
1250050	5	50	3,10 €
1250060	6	50	3,10 €
1250070	7	50	3,10 €
1250080	8	50	3,10 €
1250090	9	50	3,20 €
1250100	10	50	3,30 €
1250110	11	50	3,40 €
1250120	12	50	3,40 €
1250130	13	50	3,70 €

□ 1/2"

Referencia	A (m/m)	B (m/m)	P.V.P.
1477100	10	77	5,10 €
1477110	11	77	5,10 €
1477120	12	77	5,10 €
1477130	13	77	5,20 €
1477140	14	77	5,20 €
1477150	15	77	5,40 €
1477160	16	77	5,50 €
1477170	17	77	5,50 €
1477180	18	77	5,70 €
1477190	19	77	5,70 €
1477210	21	77	6,80 €
1477220	22	77	6,80 €
1477240	24	77	7,10 €
1477270	27	77	8,10 €
1477300	30	77	10,80 €
1477320	32	77	11,20 €

□ 3/8"

Referencia	A (m/m)	B (m/m)	P.V.P.
1363100	10	63	3,50 €
1363120	12	63	3,50 €
1363130	13	63	3,60 €
1363140	14	63	3,90 €
1363170	17	63	4,80 €
1363180	18	63	5,10 €

VASOS LARGOS 12 CARAS

□ 1/2"

Referencia	A (m/m)	B (m/m)	P.V.P.
0477080	8	77	6,10 €
0477100	10	77	6,10 €
0477110	11	77	6,10 €
0477120	12	77	6,20 €
0477130	13	77	6,20 €
0477140	14	77	6,20 €
0477150	15	77	6,40 €
0477160	16	77	6,40 €
0477170	17	77	6,50 €
0477180	18	77	6,80 €
0477190	19	77	6,90 €
0477210	21	77	7,20 €
0477220	22	77	8,50 €
0477240	24	77	8,90 €

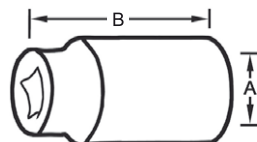

ST-29025

P.V.P: 108€

REMACHADORA PARA TUERCAS Y REMACHES

Cuerpo de aluminio, empuñadura Cr-Mo.
Dos niveles de apriete.

SCM435
para remaches:
3,2mm(1/8"), 4,0mm(5/32")
4,8mm(3/16"), 6,4mm(1/4")

SCM415
para tuercas remachables
M5, M6, M8, M10

Opcionales: M3 y M4



Ref: 2032289

ST-25515

P.V.P: 12€

VASO AUTOMATICO - CUADRADILLO DE 3/8"

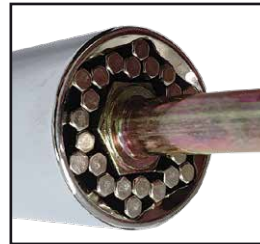

VASO AUTO ADAPTABLE
A CUALQUIER TIPO DE
TORNILLO DE 8 a 21mm



Ref: 2032318

PA-JL-RP1202

P.V.P: 30€

ALICATE DE ANILLAS (4 en 1)

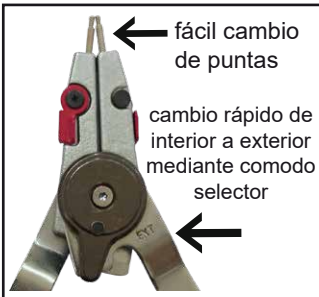

fácil cambio
de puntas

cambio rápido de
interior a exterior
mediante comodo
selector

Incluye:
Puntas rectas 1,8mm.
Puntas curvas 1,2mm.

Opcional:
Punta recta 1,2mm.

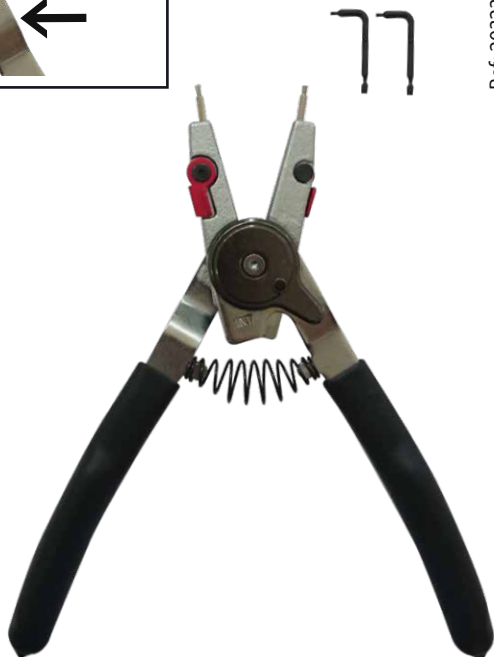

Ref: 2032312

AS-086

P.V.P: 39€

3 VASOS LARGOS PARA
LLANTAS DE ALUMINIO 1/2" LARGOS HEX

Ref: 2032550

Ref.	Ø (mm.)	P.V.P.
AS-08617	17	13,00 €
AS-08619	19	13,00 €
AS-08621	21	13,00 €



FS-943510

P.V.P: 99€

JUEGO DE VASOS TORX DE 3/8"
EXTRA LARGOS 200mm

E6 - E7 - E8 - E10 - E11 - E12 - E14 - E16 - E18 - E20



FS-933510

P.V.P: 99€

JUEGO DE PUNTAS TORX DE 3/8"
EXTRA LARGAS 200mm

T10 - T15 - T20 - T25 - T27 - T30 - T40 - T45 - T50 - T55



ADAPTADORES DE CARRACA



ADAPTADOR 2AD
(1/4" -10mm)
REF. 7202010
P.V.P: 5,00€

ADAPTADOR 3AD
(3/8" -13mm)
REF. 7203010
P.V.P: 5,00€

ADAPTADOR 4AD
(1/2" -19mm)
REF. 7204010
P.V.P: 6,00€

MANGO DESTORNILLADOR 1/4"

P.V.P: 4,90€



Ref: TK-7820SH

6PC2008017

P.V.P: 25€

JUEGO 6 ADAPTADORES



INCLUYE:

REDUCTORES:
3/8" HEMBRA A 1/4" MACHO
1/2" HEMBRA A 3/8" MACHO
3/4" HEMBRA A 1/2" MACHO

AMPLIADORES
1/4" HEMBRA A 3/8" MACHO
3/8" HEMBRA A 1/2" MACHO
1/2" HEMBRA A 3/4" MACHO

ADAPTADORES

P.V.P.	□	P.V.P.
6902003	1/4"H x 3/8"M	3,70 €
6903002	3/8"H x 1/4"M	4,40 €
6903004	3/8"H x 1/2"M	6,10 €
6904003	1/2"H x 3/8"M	5,10 €
6904006	1/2"H x 3/4"M	6,50 €
6906004	3/4"H x 1/2"M	7,10 €



EB-02005S

Descatalogado

JUEGO DE ALARGOS ANGULARES 1/4" (5 PIEZAS)

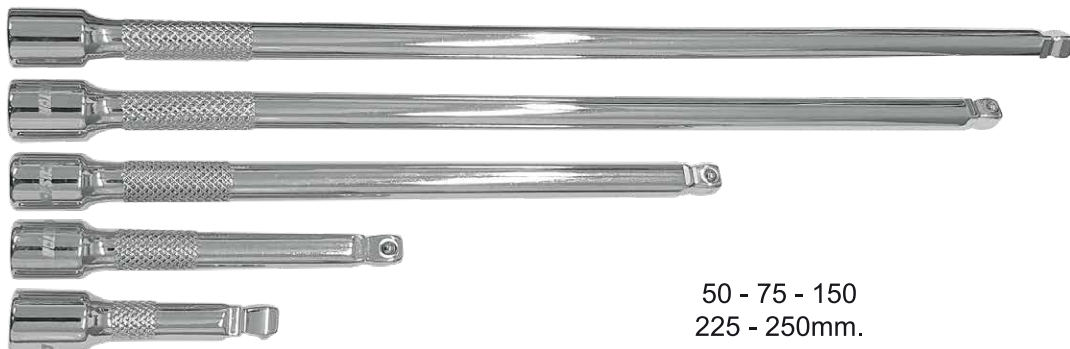

50 - 75 - 150
225 - 250mm.

Ref. 2032333

ALARGOS RECTOS

P.V.P.	Ø / largo	P.V.P.
6502050	1/4" - 50mm	3,20 €
6502075	1/4" - 75mm	3,40 €
6502100	1/4" - 100mm	3,70 €
6502150	1/4" - 150mm	4,50 €
6503075	3/8" - 75mm	4,60 €
6503150	3/8" - 150mm	6,50 €
6504125	1/2" - 125mm	8,10 €
6504250	1/2" - 250mm	12,70 €



ALARGOS ANGULARES

P.V.P.	Ø / largo	P.V.P.
6602050	1/4" - 50mm	4,10 €
6602075	1/4" - 75mm	4,60 €
6602150	1/4" - 150mm	5,40 €
6602225	1/4" - 225mm	6,40 €
6602250	1/4" - 250mm	6,80 €
6603075	3/8" - 75mm	5,70 €
6604050	1/2" - 50mm	6,80 €
6604125	1/2" - 125mm	9,10 €



ADAPTADOR PUNTAS

Referencia	Ø / punta	P.V.P.
7102002	1/4" - 1/4"	2,20 €
7103010	3/8" - 10mm	3,70 €
7104008	1/2" - 8mm	4,10 €
7104010	1/2" - 10mm	4,20 €



MANGO CORREDIZO

P.V.P.	Ø	P.V.P.
6702110	1/4"	4,70 €
6704250	1/2"	12,10 €
6706450	3/4"	33,20 €



ARTICULACIONES



7002002 P.V.P: 5,90€
ARTICULACIÓN 1/4"

7003003 P.V.P: 6,90€
ARTICULACIÓN 3/8"

7004004 P.V.P: 11,90€
ARTICULACIÓN 1/2"

AS-01A

P.V.P: 17€

JUEGO VASOS DE IMPACTO HEX. 3/8" (8, 10, 11, 13, 14, 16, 17, 19 mm.)

Referencia	Ø (mm.)	P.V.P.
AS-01A08	8	3,20 €
AS-01A10	10	3,20 €
AS-01A11	11	3,20 €
AS-01A13	13	3,20 €
AS-01A14	14	3,20 €
AS-01A16	16	3,30 €
AS-01A17	17	3,40 €
AS-01A19	19	3,50 €



Ref: 2032555

AS-02A

P.V.P: 30€

JUEGO VASOS DE IMPACTO HEX. 1/2" - 11 PIEZAS (10, 11, 12, 13, 14, 16, 17, 19, 21, 22, 24 mm.)

Referencia	Ø (mm.)	P.V.P.
AS-02A10	10	4,30 €
AS-02A11	11	4,30 €
AS-02A12	12	4,30 €
AS-02A13	13	4,30 €
AS-02A14	14	4,80 €
AS-02A15	15	4,80 €
AS-02A16	16	4,80 €
AS-02A17	17	4,80 €
AS-02A18	18	4,90 €
AS-02A19	19	4,90 €
AS-02A21	21	5,90 €
AS-02A22	22	6,10 €
AS-02A24	24	6,10 €



Ref: 2032556

AS-02B

P.V.P: 52€

JUEGO VASOS DE IMPACTO HEX. 1/2" LARGOS - 11 PIEZAS (10, 11, 12, 13, 14, 16, 17, 19, 21, 22, 24 mm.)

Referencia	Ø (mm.)	P.V.P.
AS-02B10	10	5,30 €
AS-02B11	11	5,30 €
AS-02B12	12	5,30 €
AS-02B13	13	5,30 €
AS-02B14	14	5,30 €
AS-02B16	16	6,30 €
AS-02B17	17	6,30 €
AS-02B18	18	6,30 €
AS-02B19	19	6,30 €
AS-02B21	21	6,80 €
AS-02B22	22	7,30 €
AS-02B24	24	7,80 €



Ref: 2032557

CUSTOR Vasos de impacto

AS-084T P.V.P: 56€
12 VASOS DE IMP. 1/2" DE 12 CANTOS CORTOS Ref: 2032554

AS-085T P.V.P: 90€
12 VASOS DE IMP. 1/2" DE 12 CANTOS LARGOS Ref: 2032582



Referencia cortos	Referencia largos	(mm.)	P.V.P. cortos	P.V.P. largos
AS-84T10	AS-85T10	10	4,70 €	8,20 €
AS-84T11	AS-85T11	11	4,70 €	8,20 €
AS-84T12	AS-85T12	12	4,70 €	8,20 €
AS-84T13	AS-85T13	13	5,20 €	8,20 €
AS-84T14	AS-85T14	14	5,20 €	8,20 €
AS-84T15	AS-85T15	15	5,70 €	8,20 €
AS-84T16	AS-85T16	16	5,70 €	9,20 €
AS-84T17	AS-85T17	17	6,20 €	9,20 €
AS-84T19	AS-85T19	19	6,20 €	9,20 €
AS-84T21	AS-85T21	21	6,20 €	9,70 €
AS-84T22	AS-85T22	22	6,70 €	9,70 €
AS-84T24	AS-85T24	24	7,20 €	10,20 €

AS-03AA P.V.P: 99€
JUEGO VASOS DE IMPACTO HEX. 3/4" (21, 24, 27, 30, 32, 33, 36, 38 mm.)

Referencia	Ø (mm.)	P.V.P.
AS-03AA21	21	11,00 €
AS-03AA24	24	11,00 €
AS-03AA26	26	12,00 €
AS-03AA27	27	12,00 €
AS-03AA29	29	13,00 €
AS-03AA30	30	13,00 €
AS-03AA32	32	14,00 €
AS-03AA33	33	15,00 €
AS-03AA35	35	15,00 €
AS-03AA36	36	16,00 €
AS-03AA38	38	17,00 €
AS-03AA41	41	19,00 €



Ref: 2032548

IMS03400816 P.V.P: 151€
JUEGO 8 VASOS IMPACTO HEX. 3/4" LARGOS 90mm (26 - 27 - 29 - 30 - 32 - 35 - 36 - 38mm)



Ref: 2032560

VASOS DE IMPACTO LARGOS HEX. 3/4" (90mm)

Referencia	Ø (mm.)	P.V.P.
DS-060220	22	21,30 €
DS-060270	27	21,30 €
DS-060290	29	22,30 €
DS-060300	30	22,30 €
DS-060320	32	23,30 €
DS-060330	33	24,30 €
DS-060350	35	25,30 €
DS-060360	36	25,30 €
DS-060380	38	28,30 €
DS-060440	44	35,30 €



AS-041AM

P.V.P: 169€

JUEGO VASOS DE IMPACTO HEX. CORTOS 1" (75mm) 24, 27, 30, 32, 33, 36, 38 mm.

Referencia	Ø (mm.)	P.V.P.
AS-041AM21	21	26,00 €
AS-041AM22	22	26,00 €
AS-041AM24	24	26,00 €
AS-041AM27	27	27,00 €
AS-041AM29	29	27,00 €
AS-041AM30	30	27,00 €
AS-041AM32	32	27,00 €
AS-041AM33	33	27,00 €
AS-041AM35	35	27,00 €
AS-041AM36	36	27,00 €
AS-041AM38	38	28,00 €
AS-041AM41	41	29,00 €



Ref: 2032549



VASOS DE IMPACTO PARED REBAJADA 1" HEX. LARGOS (108mm.)

Referencia	Ø (mm.)	P.V.P.
2032410	27	35,50 €
2032411	30	35,50 €
2032412	32	35,50 €
2032413	33	35,50 €



AS-814ADP

JUEGO 4 AMPLIADORES Y 4 REDUCTORES DE IMPACTO

P.V.P: 78€

Ref: 2032262

Amplificador Ref.	A	B	P.V.P.
SK14A38	1/4"	3/8"	5,50 €
SK38A12	3/8"	1/2"	6,50 €
SK12A34	1/2"	3/4"	10,50 €
SK34A10	3/4"	1"	21,50 €

Reductor Ref.	A	B	P.V.P.
SK10A34	1"	3/4"	26,50 €
SK34A12	3/4"	1/2"	16,50 €
SK12A38	1/2"	3/8"	7,50 €
SK38A14	3/8"	1/4"	5,50 €

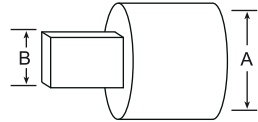
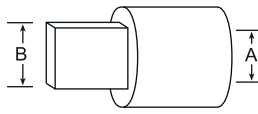

ADP000601

JUEGO 3 AMPLIADORES Y 3 REDUCTORES DE IMPACTO

P.V.P: 47€

REDUCTORES:
3/8" A 1/4"
1/2" A 3/8"
3/4" A 1/2"

AMPLIADORES
1/4" A 3/8"
3/8" A 1/2"
1/2" A 3/4"



UJ-020043

ARTICULACIÓN DE IMPACTO 1/4"

P.V.P: 7€



AS-67

EXTRACTORES DE TORNILLOS DETERIORADOS 4 PZ. 1/2": 17 - 19 - 21 y 22 mm.

P.V.P: 69€

UJ-040075

ARTICULACIÓN DE IMPACTO 1/2"

P.V.P: 12,50€



Ref: 2032553



AS-092

P.V.P: 39€

EXTRACTORES DE TORNILLOS 3/8" (2, 3, 4, 6, 8, 10 mm.)



Ref: 2032552



AS-088

P.V.P: 65€

JUEGO DE VASOS PUNTA TORX (CrMo) DE 8 PIEZAS 1/2" (T25 - T27 - T30 - T40 - T45 - T50 - T55 - T60)



Ref: 2032283

Referencia	Medida	Largo	P.V.P.
AS-088-T20	T20	78	9,00 €
AS-088-T25	T25	78	9,00 €
AS-088-T27	T27	78	9,00 €
AS-088-T30	T30	78	9,00 €
AS-088-T40	T40	78	9,00 €
AS-088-T45	T45	78	9,50 €
AS-088-T50	T50	78	9,50 €
AS-088-T55	T55	78	10,50 €
AS-088-T60	T60	78	10,50 €

AS-73

P.V.P: 95€

EXTRACTORES DE TORNILLOS HEXAGONALES (8, 10, 11, 12, 13, 14, 15, 16, 17, 19 mm.)



Ref: 2032551



AS-87

P.V.P: 65€

JUEGO DE VASOS PUNTA IMPACTO HEX. DE 8 PZ 1/2" (6 - 7 - 8 - 10 - 12 - 14 - 17 - 19 mm)



Ref: 2032296

Referencia	Medida	Largo	P.V.P.
AS-87-6	6	60	9,00 €
AS-87-7	7	60	9,00 €
AS-87-8	8	60	9,00 €
AS-87-10	10	60	9,00 €
AS-87-12	12	60	9,00 €
AS-87-14	14	60	9,50 €
AS-87-17	17	78	10,50 €
AS-87-19	19	78	10,50 €

CUSTOM Vasos punta / Puntas 10mm

VASO PUNTA 1/4" PLANA

Referencia	A (mm)	B (mm)	Ø (mm)	L (mm)	P.V.P.
3804037	4	18	14	37	2,70 €
3805537	5,5	18	14	37	2,70 €
3806537	6,5	18	14	37	2,70 €

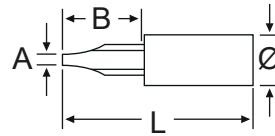

VASO PUNTA 1/4" HEXAGONAL

Referencia	A (mm)	B (mm)	Ø (mm)	L (mm)	P.V.P.
3903037	3	18	14	37	2,70 €
3904037	4	18	14	37	2,70 €
3905037	5	18	14	37	2,70 €
3906037	6	18	14	37	2,70 €
3908037	8	18	14	37	2,70 €

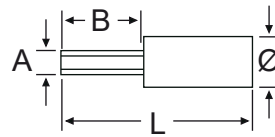

PUNTA 10 mm. HEXAGONAL CORTA

Referencia	A (mm)	B (mm)	Ø (mm)	L (mm)	P.V.P.
2900430	4	15	10	30	2,70 €
2900530	5	15	10	30	2,70 €
2900630	6	15	10	30	2,70 €
2900730	7	15	10	30	2,70 €
2900830	8	15	10	30	2,70 €
2901030	10	15	10	30	3,20 €
2901230	12	15	10	30	3,20 €

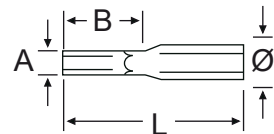

PUNTA 10 mm. TORX CORTA

Referencia	A (mm)	B (mm)	C (mm)	L (mm)	P.V.P.
3502030	T20	15	10	30	2,70 €
3502530	T25	15	10	30	2,70 €
3502730	T27	15	10	30	2,70 €
3503030	T30	15	10	30	2,70 €
3504030	T40	15	10	30	2,70 €
3504530	T45	15	10	30	2,70 €
3505030	T50	15	10	30	2,70 €
3505530	T55	15	10	30	2,70 €
3506030	T60	15	10	30	3,00 €

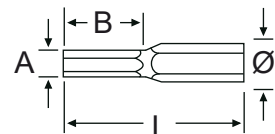

PUNTA 10 mm. XZN CORTA

Referencia	A (mm)	B (mm)	C (mm)	L (mm)	P.V.P.
3700530	M-5	15	10	30	2,70 €
3700630	M-6	15	10	30	2,70 €
3700830	M-8	15	10	30	2,70 €
3701030	M-10	15	10	30	2,80 €
3701230	M-12	15	10	30	3,20 €

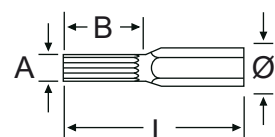

VASO PUNTA 1/4" PH Y PZ

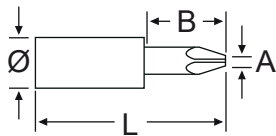

Referencia	A (mm)	B (mm)	Ø (mm)	L (mm)	P.V.P.
4300137	PH1	18	14	37	2,70 €
4300237	PH2	18	14	37	2,70 €
4400137	PZ1	18	14	37	2,70 €
4400237	PZ2	18	14	37	2,70 €

VASO PUNTA 1/4" TORX

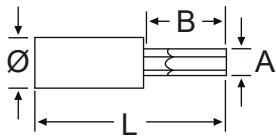

Referencia	A (mm)	B (mm)	Ø (mm)	L (mm)	P.V.P.
4501037	T10	18	14	37	2,70 €
4501537	T15	18	14	37	2,70 €
4502037	T20	18	14	37	2,70 €
4502537	T25	18	14	37	2,70 €
4502737	T27	18	14	37	2,70 €
4503037	T30	18	14	37	2,70 €
4504037	T40	18	14	37	2,70 €

PUNTA 10 mm. HEXAGONAL LARGA

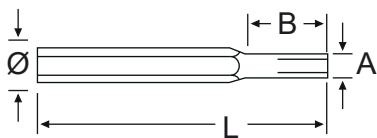

Referencia	A (mm)	B (mm)	Ø (mm)	L (mm)	P.V.P.
2900475	4	15	10	75	3,30 €
2900575	5	15	10	75	3,30 €
2900675	6	15	10	75	3,30 €
2900775	7	15	10	75	3,30 €
2900875	8	15	10	75	3,30 €
2901075	10	15	10	75	3,30 €
2901275	12	15	10	75	4,80 €

PUNTA 10 mm. TORX LARGA

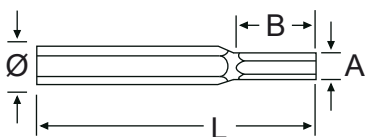

Referencia	A (mm)	B (mm)	C (mm)	L (mm)	P.V.P.
3502075	T20	15	10	75	3,20 €
3502575	T25	15	10	75	3,20 €
3502775	T27	15	10	75	3,20 €
3503075	T30	15	10	75	3,20 €
3504075	T40	15	10	75	3,20 €
3504575	T45	15	10	75	3,20 €
3505075	T50	15	10	75	3,20 €
3505575	T55	15	10	75	3,30 €
3506075	T60	15	10	75	4,80 €

PUNTA 10 mm. XZN LARGA

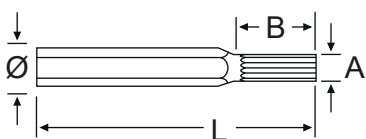

Referencia	A (mm)	B (mm)	C (mm)	L (mm)	P.V.P.
3700575	M-5	15	10	75	3,30 €
3700675	M-6	15	10	75	3,30 €
3700875	M-8	15	10	75	3,30 €
3701075	M-10	15	10	75	3,30 €
3701275	M-12	15	10	75	4,80 €

MADRID

Av. de Castilla, 23, Nave 2A
28830 San Fernando de Henares
(Madrid)
Tel. 91 037 57 93

BARCELONA

Pol. Ind. Can Comelles Sud
Prensa s/n, Nave 12
08292 Esparreguera (Barcelona)
Tel. 93 770 83 00 - Fax 93 770 88 20

abinca@abinca.com